

MICRODOS

Pooltec

Installation, Programming and Maintenance User Guide



Content

1.	IMPORTANT SAFETY INSTRUCTIONS	5
1.1.	ELECTRICAL SPECIFICATIONS AND FEATURES	5
2.	MICRODOS POOLTEC CONTENT	6
2.1.	INCLUDED ITEMS.....	6
2.2.	OPTIONS.....	6
2.3.	ACCESSORIES.....	7
2.4.	MICRODOS POOLTEC DIMENSIONS	7
2.5.	MICRODOS POOLTEC PANEL DIMENSIONS	7
3.	MICRODOS POOLTEC SYSTEM INSTALLATION	8
3.1.	PLUMBING	8
3.1.1.	CONTROL UNIT INSTALLATION	8
3.1.2.	PROBES AND INJECTIONS.....	8
3.2.	ELECTRICITY	9
3.2.1.	ELECTRIC CONNECTION OF THE CONTROL UNIT	9
3.2.2.	CONNECTING UP THE MAIN PUMP TO MICRODOS POOLTEC	10
3.2.3.	FRONT PANEL OPENING/CLOSING	10
3.2.4.	INTERCONNECTIONS	11
3.2.4.1.	PH-RX MP2-B PUMPS.....	12
3.2.4.2.	PH-CL CG CL3 MP2-B PUMPS.....	12
3.2.4.3.	PH-CL CP MP2-B PUMPS.....	13
3.2.4.4.	PH-RX MA PUMPS.....	13
3.2.4.5.	PH-CL CG CL3 MA PUMPS	14
3.2.4.6.	PH-CL CP MA PUMPS	14
4.	PROGRAMMING THE CONTROL UNIT	15
4.1.	HOME PAGE: REAL-TIME INFORMATION	15
4.2.	ICONS.....	16
4.3.	AUTO FUNCTIONING	17
4.4.	MANUAL FUNCTIONING.....	18
4.5.	PROGRAMMING THE SYSTEM	19
4.5.1.	PASSWORD	19
4.5.2.	PROGRAMS: PROGRAMMING RECIRCULATION PUMP	19
4.5.2.1.	AUTOTEMP:.....	20
4.5.2.2.	USER PROGRAM.....	21
4.5.2.3.	PUBLIC POOL.....	22
4.5.2.4.	WINTER.....	23
4.5.3.	SETTINGS.....	24
4.5.3.1.	MODIFY PARAMETERS VALUE	24
4.5.3.2.	GENERAL:	25
4.5.3.2.1.	GENERAL FLOW ALARM.....	25
4.5.3.3.	MEASUREMENT (PH, RX, CL) FUNCTION (BASIC/EXPERT).....	26
4.5.3.4.	PROBES CALIBRATION	27
4.5.3.4.1.	CALIBRATING THE PH PROBE	27
4.5.3.4.2.	CALIBRATE THE RX PROBE	28
4.5.3.4.3.	CALIBRATE THE AMPEROMETRIC CHLORINE PROBE	29

4.5.3.4.4.	CALIBRATE THE POTENTIOSTATIC CHLORINE PROBE	31
4.5.3.5.	TEMPERATURE.....	33
4.5.3.6.	AUXILIARY OUTPUTS CONFIGURABLE TYPES	34
4.5.3.6.1.	TIMER TYPE.....	34
4.5.3.6.2.	MICRODOSE TYPE.....	35
4.5.3.6.3.	REPEAT TYPE.....	36
4.5.3.6.4.	DRY AUXILIARY OUTPUTS	37
4.5.3.6.5.	LIGHTS.....	37
4.5.3.6.6.	HEATING FUNCTION	38
4.5.3.7.	MA OUTPUT (OPTIONAL)	39
4.5.3.8.	CONFIG MENU	40
4.5.4.	DEVICE SETTINGS.....	41
4.5.4.1.	SET THE SLEEP TIMER OF THE SCREEN	41
4.5.4.2.	CONNECTION WIFI OR ETHERNET	41
4.5.4.3.	DATE AND TIME	42
4.5.4.4.	CHANGING THE LANGUAGE	43
4.5.4.5.	ACTIVATE/DEACTIVATE REMOTE CONTROL	43
4.5.4.6.	UPDATE SOFTWARE (DOWNLOAD).....	44
4.5.4.7.	DEVICE INFO: SYSTEM MODEL AND SERIAL NUMBER: SOFTWARE VERSION	44
4.5.4.8.	MEASUREMENT HISTORY.....	45
5.	POOLTEC PRO	46
5.1.	REGISTRATION	46
5.1.1.	NEW USER REGISTRATION	46
5.1.2.	NEW DEVICE REGISTRATION	47
5.2.	APP.....	48
5.2.1.	ANDROID APP	48
5.2.2.	IOS APP.....	48
6.	STARTING UP	49
6.1.	DEFAULT CONFIGURATION	49
6.2.	RECOMMENDED TIME SCHEDULE FOR PRIVATE/PUBLIC POOLS.....	50
7.	MAINTENANCE OF THE MICRODOS POOLTEC.....	50
7.1.	MAINTENANCE AND CONTROL PANEL	50
7.2.	BATTERY REPLACEMENT	51
8.	INCOMPATIBILITIES	51



WARNINGS

Please read carefully the instructions given below, as they supply you with all the needed information, necessary for installation, use and maintenance.

Once you receive the MICRODOS POOLTEC check out for its integrity and all its components, in case of any anomalies, please consult a skilled staff before making any operation. The equipment must be operated by skilled persons.

For a correct functioning it is necessary to use original spare parts and original accessories. Microdos declines whatever responsibility in reference to break down due to tampering or the use of not original spare parts and accessories.

The electrical plant must be in conformity with the rules of the country where it is realised.

During maintenance and repair of parts in contact with chemicals, always use personal protection measures (gloves, aprons, goggles, etc.).

The usage room temperature cannot overtake 45 °C. The minimum temperature depends on the chemical that must remain in the liquid state.

Microdos declines all responsibility in reference to any intervention on the equipment from a non-skilled staff.



HAZARDS

Ignoring the instructions can result in equipment damage and, in extreme cases, injury to persons.

Before installing the equipment make sure that the electrical data reported on the label correspond to those of your electrical plant.

All maintenance or repair must be performed with the system electrically isolated.

Whenever you need to access the connection box, turn off MICRODOS POOLTEC and isolate it electrically.

Do not operate on the equipment with wet hands or feet.

Do not leave the equipment exposed to the action of atmospheric agents.

In case of an improper functioning of the equipment switch off and contact our technical assistance for any reparation request.



WARNING: PROPER AND IMPROPER USE

The instrument MICRODOS POOLTEC should be used only for the purposes for which it was designed that is, the measurement and control of the values of the chemical and physical parameters.

Uses other than these are considered improper and therefore dangerous.

The instrument is NOT designed for use in environment with danger of explosion.

Microdos declines any responsibility for any damage resulting from the improper and / or unreasonable use of the instrument.

WARRANTY CERTIFICATE

The controllers manufactured by Microdos are warranted to be free from defects in workmanship and material for 24months of operation starting from the delivery date to the first purchaser.

Within the above stated period Microdos will supply free of charge any part that upon examination by Microdos or by an authorised dealer, is disclosed to have been defective in workmanship or material, or at its option, it will repair the parts directly or through authorized workshops. It remains anyway excluded from whatever responsibility and obligation for other costs, damages and direct or indirect losses that come from the use or the not use availability, either total or partial. They remain anyway at charge of the purchaser the costs of plan controllers mounting and disassembling, transport cost and using materials. Producer's' duties, as above are not valid when:

The controllers are not used according to Microdos's instructions as in the operating manual and maintenance instructions.

The controllers are repaired, disassembled, modified by workshops not authorized from Microdos.

They have used not original spare parts.

The electronic plans have been damaged because of external causes such as whatever type of over tensions.

At the end of the 24 months from the delivery date, Microdos will be free from any liability and from all the duties as above. This guarantee, that starts from the 1st of January 2006, nullifies and substitutes whatever guarantee, expressed or implicit, and cannot be modified but in writing.



Design standard

Built accordingly to the current general standards endowed with CE mark in conformity with the following European directives:

- 2014/30/CE regarding "electromagnetic compatibilities".
- 2014/35/CE regarding "low voltages",
- 2014/53/EU "RED Radio Equipment Directive"

TECHNICAL DATA

- **Maximum ambient temperature:** 45 °C
- **IP:** 55
- **Material:** ABS
- **Electrical data:** see type plate on the unit.

Frequency and transmission power data referred to the pump with wi-fi circuit:

- **Transmission frequency:** DFS transmission protocol on 2.4GHz and 5GHz
- **Power:** 20dB

1. IMPORTANT SAFETY INSTRUCTIONS



PLEASE READ AND FOLLOW THESE INSTRUCTIONS

It is essential when installing a control and disinfection system at a pool to take certain precautions while handling equipment, also more generally when using the pool.

DANGER: Low-voltage electricity risk: Do not open or touch the control unit: there is a risk of electric shock. Contact your local retailer or the manufacturer. Follow the electricity safety instructions specified by your company, also local or national regulations.



DANGER: Risk of accidents or drowning: Use of the pool calls for special care. Observe the safety and hygiene instructions laid down. These are displayed near the pool, or in accordance with local or national regulations.

1.1. ELECTRICAL SPECIFICATIONS AND FEATURES

ELECTRICAL SPECIFICATIONS:

Power supply	110÷230 VAC
Operating frequency	50 Hz
Energy consumption when not running	120 mA.
Operating temperature	+ 5° / + 55 °C
Maximum operating humidity	95% with no condensation
Protection of the environment	IP55

OPERATING ALGORITHMS:

Manual/ automatic operation?	Yes
User programs?	Yes
Temperature display	At 0°/55 °C intervals; accurate to +/- 0.1°C
pH display	At 0/14 pH intervals
ORP display	At intervals of 0/1000 mV.
Automatic pH dose corrector	By peristaltic/solenoid pump
Automatic Rx dosing	By peristaltic/solenoid pump
Touch-screen	Colour 10"
Programming	By touchscreen and passwords (expert and installer)
Type of programming	User-friendly and intuitive



WARNINGS FOR GENERAL OPERATION OF MICRODOS POOLTEC

1. VERIFY PROGRAMMING AFTER UPDATING THE DEVICE: TIME PROGRAMMING, PH AND RX SET POINTS, HEATING, ETC...
2. ACCESS CODE – For menus and special functions:

Expert Password	11222
Installer Password	07591

The installer password can be changed (see page 40)

ATTENTION: the device is designed to stay on 24 hours a day, avoiding frequent shutdown cycles.

2. MICRODOS POOLTEC CONTENT

2.1. INCLUDED ITEMS





	<p>1 x CONTROL UNIT</p>		<p>1 x TEMPERATURE PROBE</p>
---	-------------------------	--	------------------------------

2.2. OPTIONS

<p>PH KIT</p> <ul style="list-style-type: none"> - 1 x pH Peristaltic/Solenoid Pump - 1 x pH Probe - 2 x Buffer Solution (7 / 9 pH) - 1 x PVC Hose - 1 x PE Hose - 1 x Injection Valve - 1 x Aspiration Filter - 1 x Probe Holder 	
<p>REDOX KIT</p> <ul style="list-style-type: none"> - 1 x Rx Peristaltic/Solenoid Pump - 1 x Rx Probe - 1 x Buffer Solution (468 mV) - 1 x PVC Hose - 1 x PE Hose - 1 x Injection Valve - 1 x Aspiration Filter - 1 x Probe Holder - Redox Software 	
<p>AMPEROMETRIC / POTENTIOSTATIC CHLORINE KIT</p> <ul style="list-style-type: none"> - 1 x CL Peristaltic/Solenoid Pump - 1 x CL Probe Panel - 1 x PVC Hose - 1 x PE Hose - 1 x Injection Valve - 1 x Aspiration Filter - Chlorine Software 	

ATTENTION: the components included in the panel version vary according to the model.

2.3. ACCESSORIES

ENVIRONMENTALLY FRIENDLY DESCALING	FLOW SENSOR	LEVEL SENSOR	GRIPPING COLAR
			

2.4. MICRODOS POOLTEC DIMENSIONS

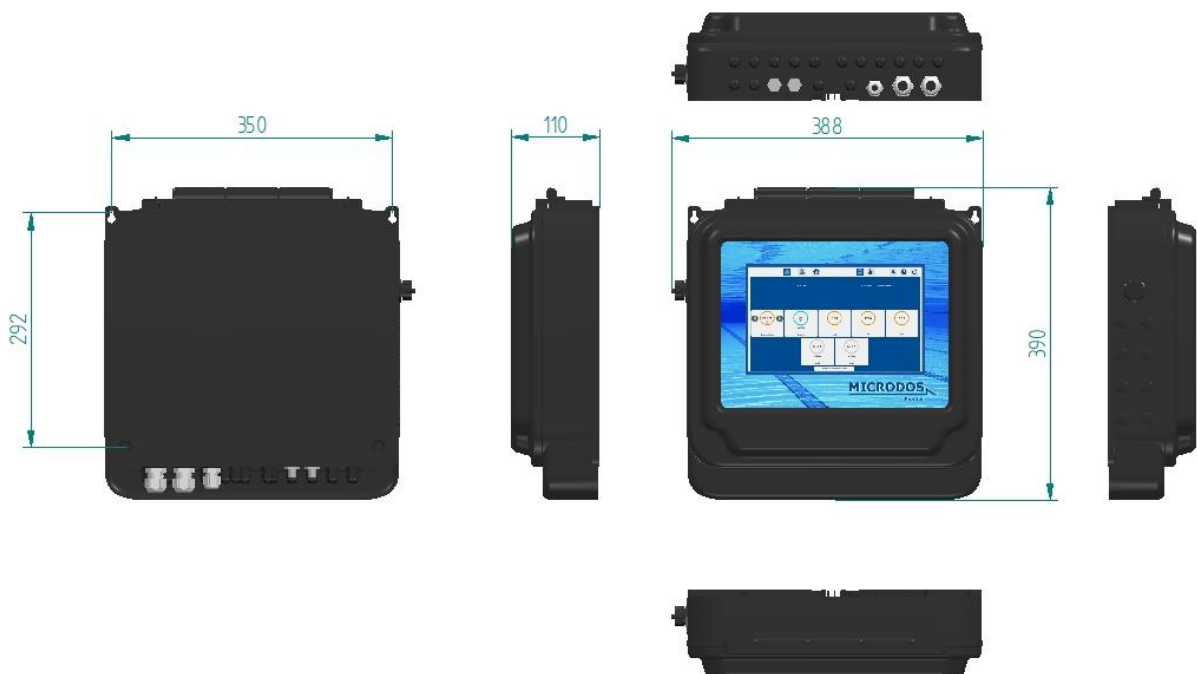

2.5. MICRODOS POOLTEC PANEL DIMENSIONS

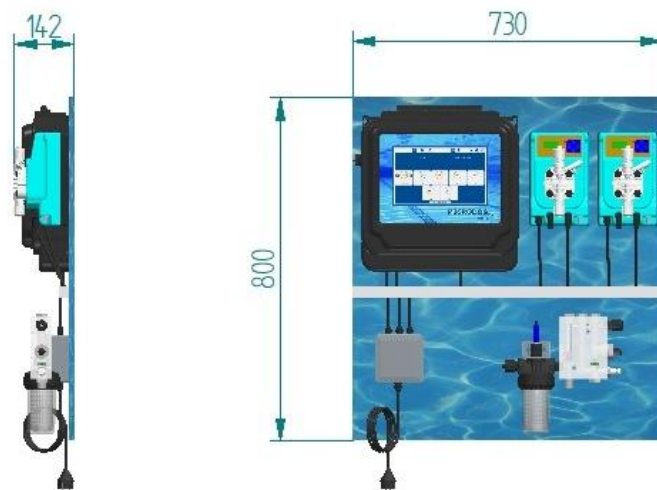

3. MICRODOS POOLTEC SYSTEM INSTALLATION

3.1. PLUMBING

ORIENTATIVE DIAGRAM

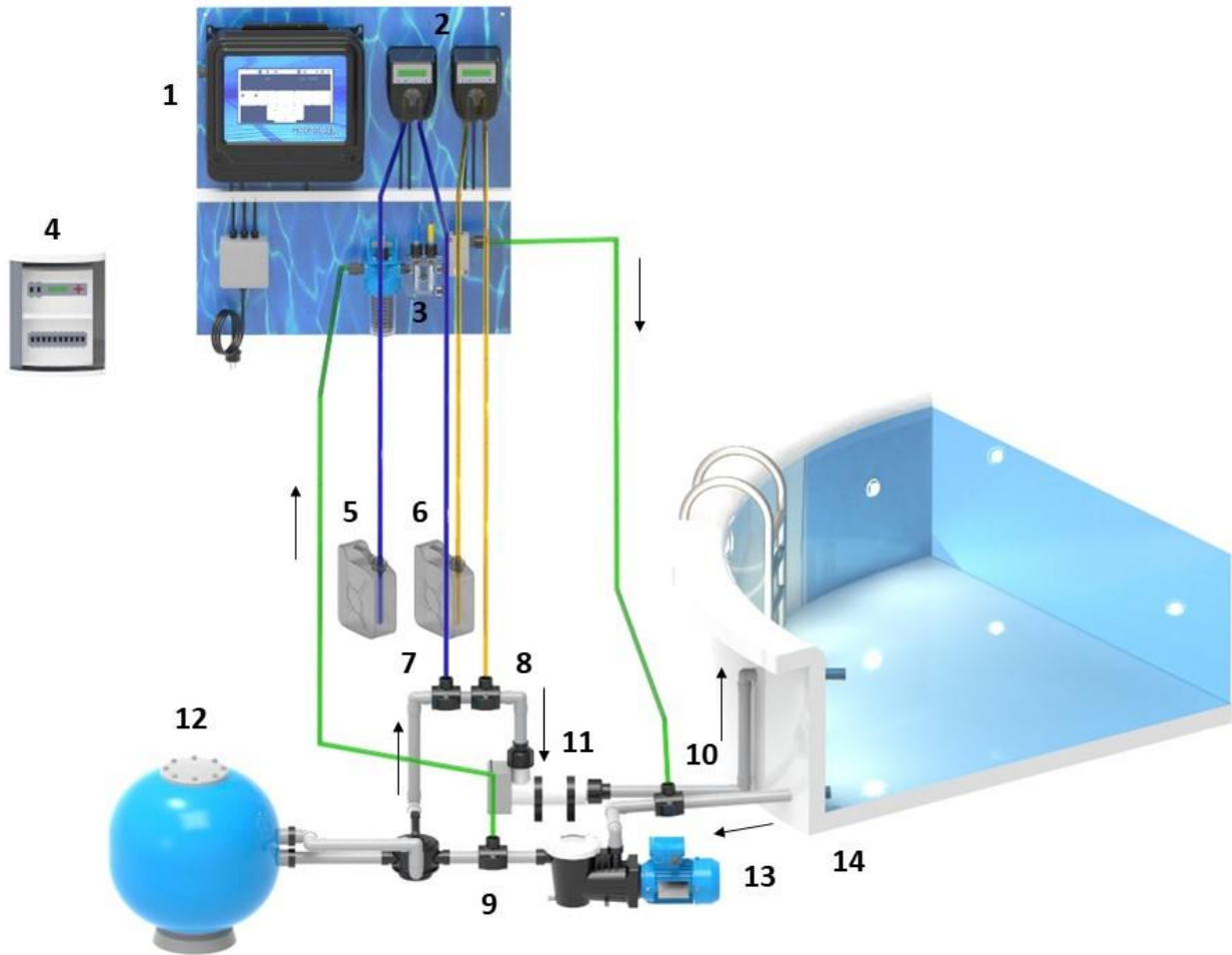

- | | | | |
|-------------------------------|-----------------------|------------------|------------------------|
| 1. Control unit | 5. pH tank | 9. Inlet water | 13. Recirculation pump |
| 2. Peristaltic/solenoid pumps | 6. Chlorine tank | 10. Outlet water | 14. Swimming pool |
| 3. Analysis group | 7. pH injection | 11. Heat pump | |
| 4. Electric panel | 8. Chlorine injection | 12. Filter | |

3.1.1. CONTROL UNIT INSTALLATION

Fix the **control unit AT LESS THAN 3 METERS** and dosing pumps to the wall close to the compartment, near the product deposits.

3.1.2. PROBES AND INJECTIONS

For installation of the pH probe and injection canal, you should use the probe-holder.

WARNINGS:



Do not leave the system without water when probes are installed. If pH or RX probes dry out, they will be damaged and cannot be used.

For maintenance of the chlorine probe, consult the manual of the chlorine probe.

USE OF SULPHURIC ACID AS PH REDUCER.

USE OF CHLORIDRIC ACID, DRASTICALLY REDUCE THE LIFETIME OF THE SILICON INJECTION PIPES

3.2. ELECTRICITY

3.2.1. ELECTRIC CONNECTION OF THE CONTROL UNIT

The system is supplied ready to be used in the installations. There is no need for any power adaptor, but we recommend installing a motor protector before connecting to the mains, to avoid a possible surge in voltage that would severely damage Microdos Pooltec's electronics (Such problems are not covered under the guarantee). (See illustration).

Place the power cables of the control unit to the electrical box of the pump with protector or plugging into an outlet of the engine room.

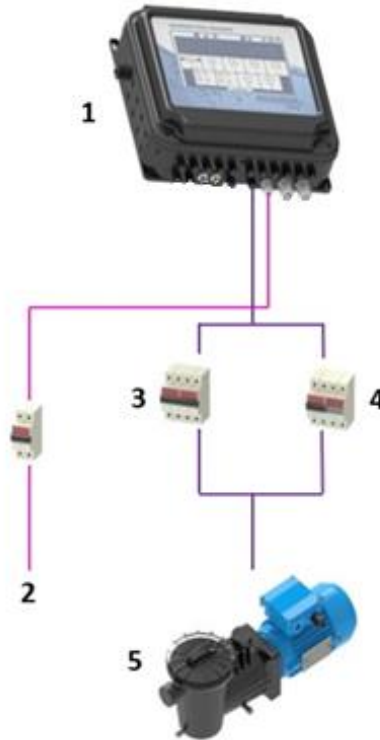

1. Microdos Pooltec control unit
2. Overload switch 230 Vac

3. Contactor
4. Motor guard

5. Recirculation pump

We remind installers that Microdos POOLTEC has only one power input, which goes from the control unit to the main power grid. We must be careful **not to connect the pump or any component to the main power supply.**

The power supply to the peripheral circuit systems is provided as follows:

PERISTALTIC PUMPS (MP2-B) for pH, Redox, Peroxide Direct outlet to the mains (*)
 PERISTALTIC/SOLENOID PUMPS (MP2-HT/ME3) for pH, Redox, Peroxide Direct to the main power grid
 RECIRCULATION PUMP Dry contact (**)

(*) The voltage output depends on the mains input. If the mains are 117VAC, the output to the peristaltic pump will be 117VAC; if the mains is 230VAC, the peristaltic pump output will be 230VAC.

(**) POOLTEC's cut-off relay is 5 amps at 230VAC: we therefore need to use contactors or motor shields with a consumption coil less than or equal to 5 amps at 230VAC.



Since Microdos Pooltec is a pool manager, it should control and command the recirculation pump.

IMPORTANT: It is also possible to choose not to manage the recirculation pump working time (NO PROGRAM).
 In this case, however, Microdos Pooltec cannot allow the functioning of HEATING.

3.2.2. CONNECTING UP THE MAIN PUMP TO MICRODOS POOLTEC

Microdos Pooltec connects/disconnects the coil of the recirculation-pump contactor. For this, we create a bridge with the Microdos Pooltec at the cable that runs from the pump's circuit-breaker to the A2 of the contactor's coil (SEE BELOW).

CONNECTING OF THE CIRCULATION PUMP TO ELECTRIC PANEL AND TO MICRODOS POOLTEC

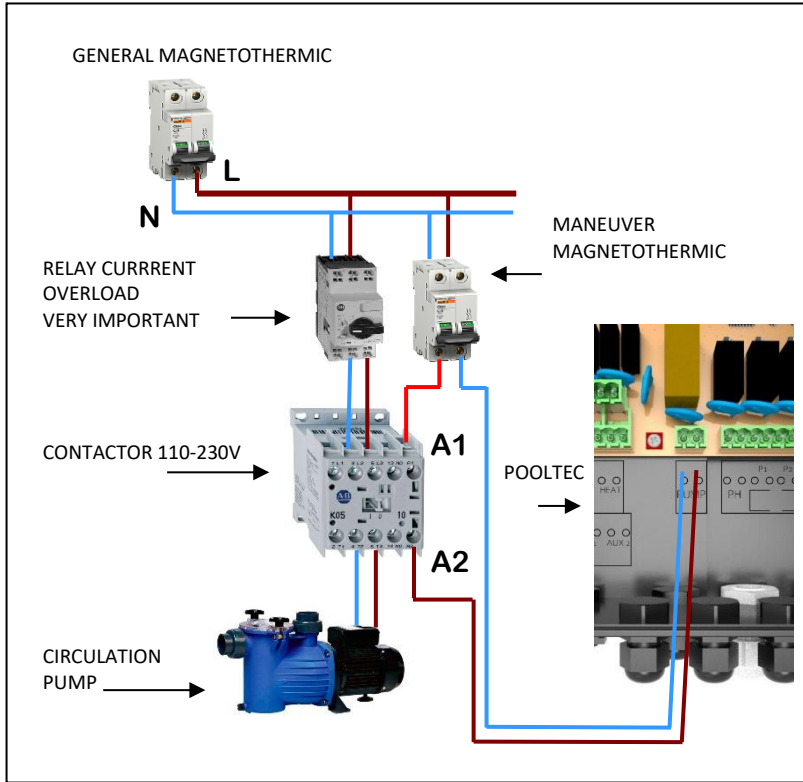

If the recirculation pump already has a timer, do not connect it to POOLTEC or set it to manual (24 hour operation).

3.2.3. FRONT PANEL OPENING/CLOSING



OPENING

To access the connection compartment it is necessary to open the front panel:

- Unscrew the 2 screws
- Remove the cover



CLOSING

To close the front panel it is necessary to hold the 2 tabs on the back at the same time, as indicated by the red arrows.

3.2.4. INTERCONNECTIONS

Below we see the connections that can be made with Microdos POOLTEC.
All connections are without electric current, except:



the dosing pumps (PH, P1,P2,P3,P4), mains supply (POWER) which are electrically POWERED.
The voltage output depends on the mains input. If the mains is 230VAC, the peristaltic pump output will be 230VAC.

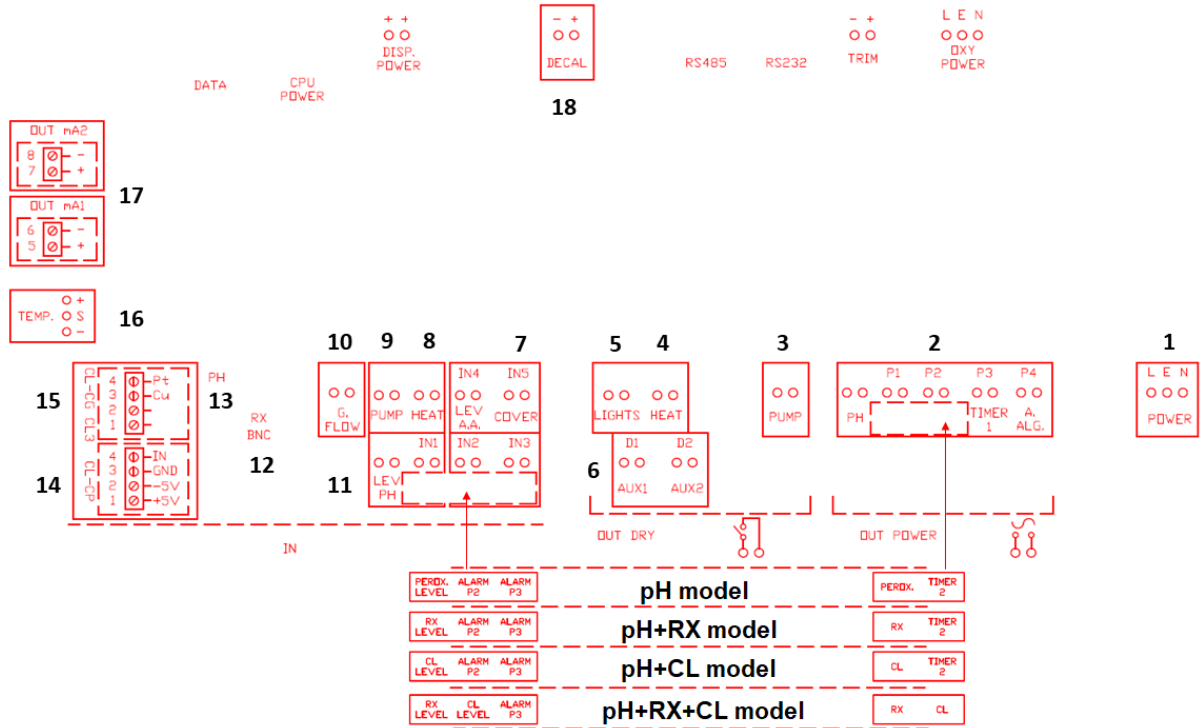

Terminal	Description
1	Main power connection (Max 240 Vac) (L - brown, E - yellow/green, N blue)
2	Output power connection (230 Vac) for pH, Rx, Cl, Algicide and auxiliary pump. (PH, P1,P2,P3,P4). (Max 10A, 230Vac)
3	Connection to the MAIN PUMP (filtration) of the pool at a DRY CONTACT. (Max 5A, 230Vac)
4	Connection to the HEAT PUMP (dry contact WITHOUT ELECTRIC CURRENT N.A.) (Max 5A,230Vac)
5	Connection to the LIGHTS (dry contact WITHOUT ELECTRIC CURRENT N.A.) (Max 5A,230Vac)
6	Connection AUX 1 and AUX 2 (dry contact WITHOUT ELECTRIC CURRENT N.A.) (Max 5A,230Vac)
7	Connection input from COVER
8	Connection input from HEATING alarm
9	Connection input from MAIN PUMP alarm
10	Connection input from FLOW sensor (N. O.)
11	Connection input from LEVEL sensor for pH, Rx, Cl, Algicide and auxiliary pump
12	BNC connection to Rx probe
13	BNC connection to pH probe
14	Connection to potentiostatic chlorine (4 = white, 3 = yellow, 2 = brown, 1 = green)
15	Connection to amperometric chlorine (4 = brown, 3 = blue)
16	Connection to temperature probe (- = green, s = yellow, + = white)
17	mA output connection
18	Connection to descaling

3.2.4.1. PH-RX MP2-B PUMPS

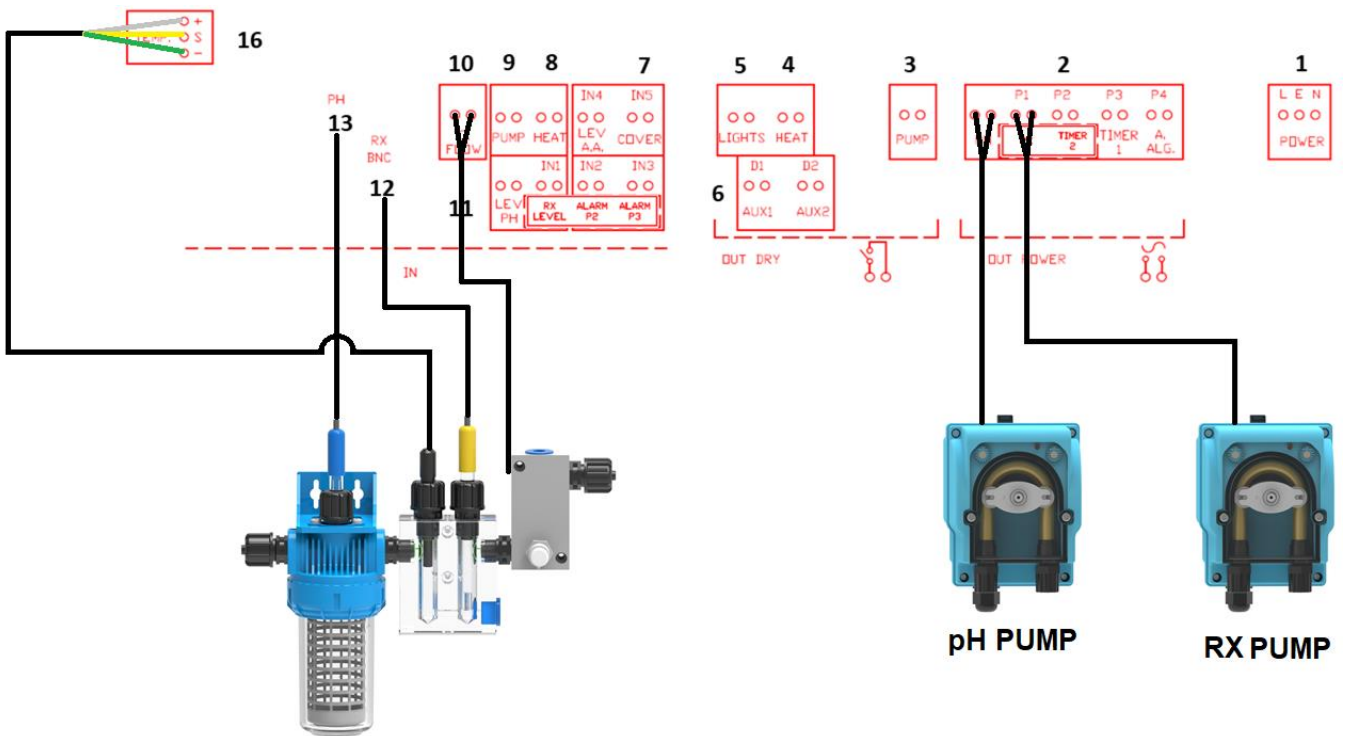

3.2.4.2. PH-CL CG CL3 MP2-B PUMPS

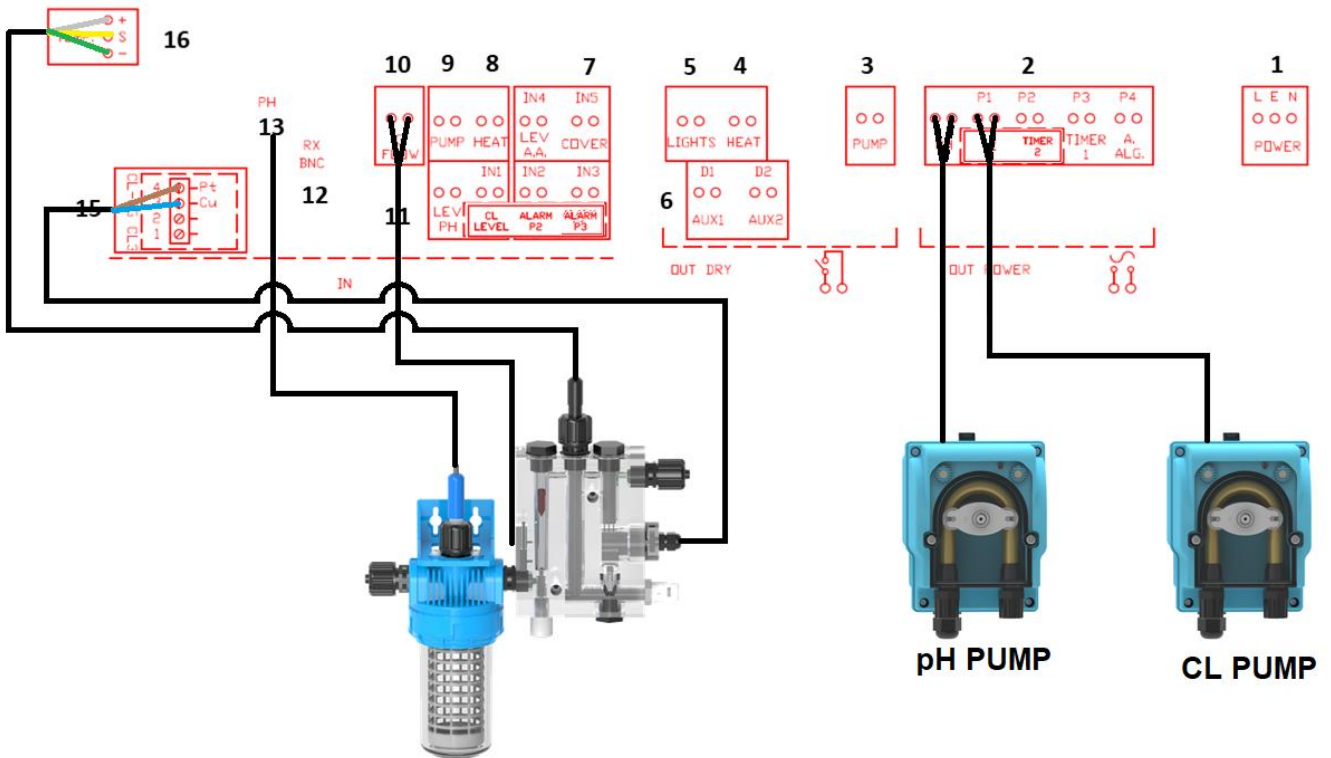

3.2.4.3. PH-CL CP MP2-B PUMPS

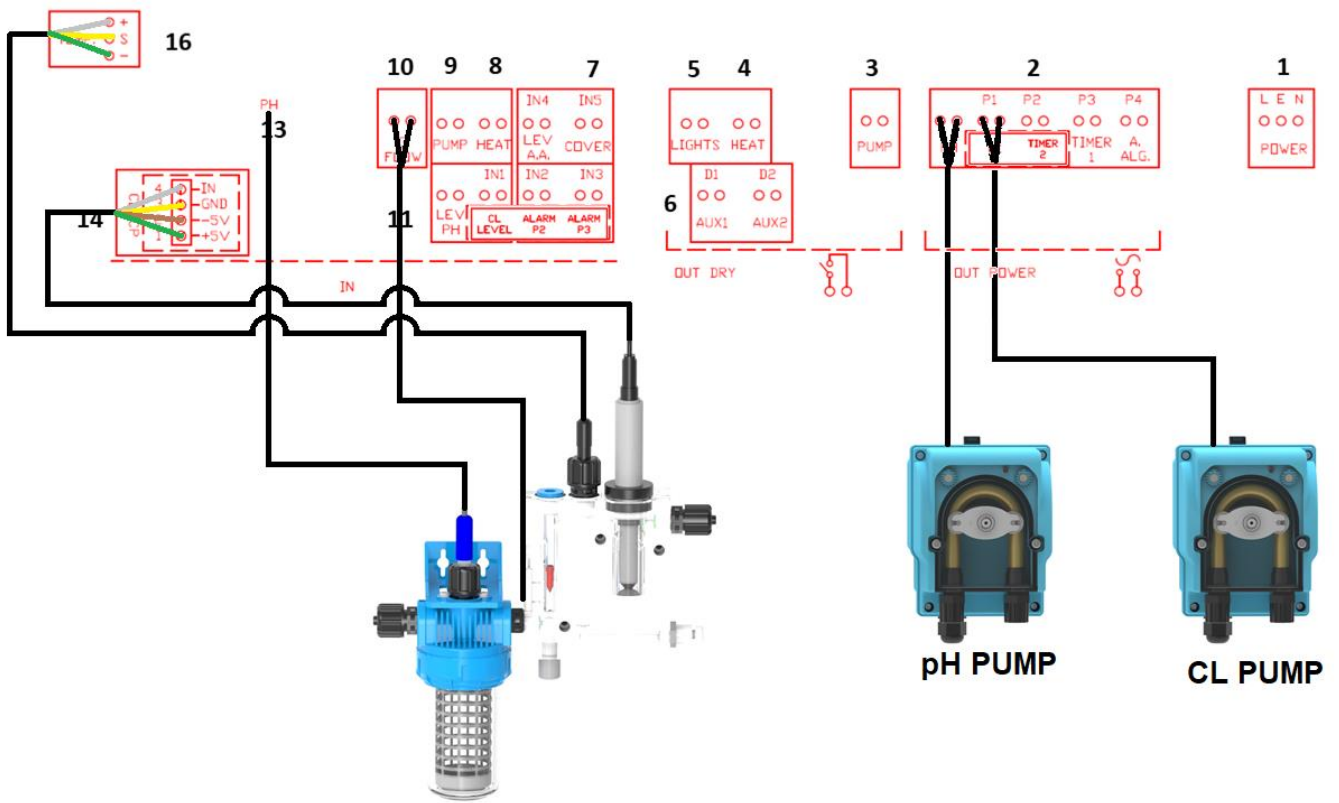

3.2.4.4. PH-RX mA PUMPS

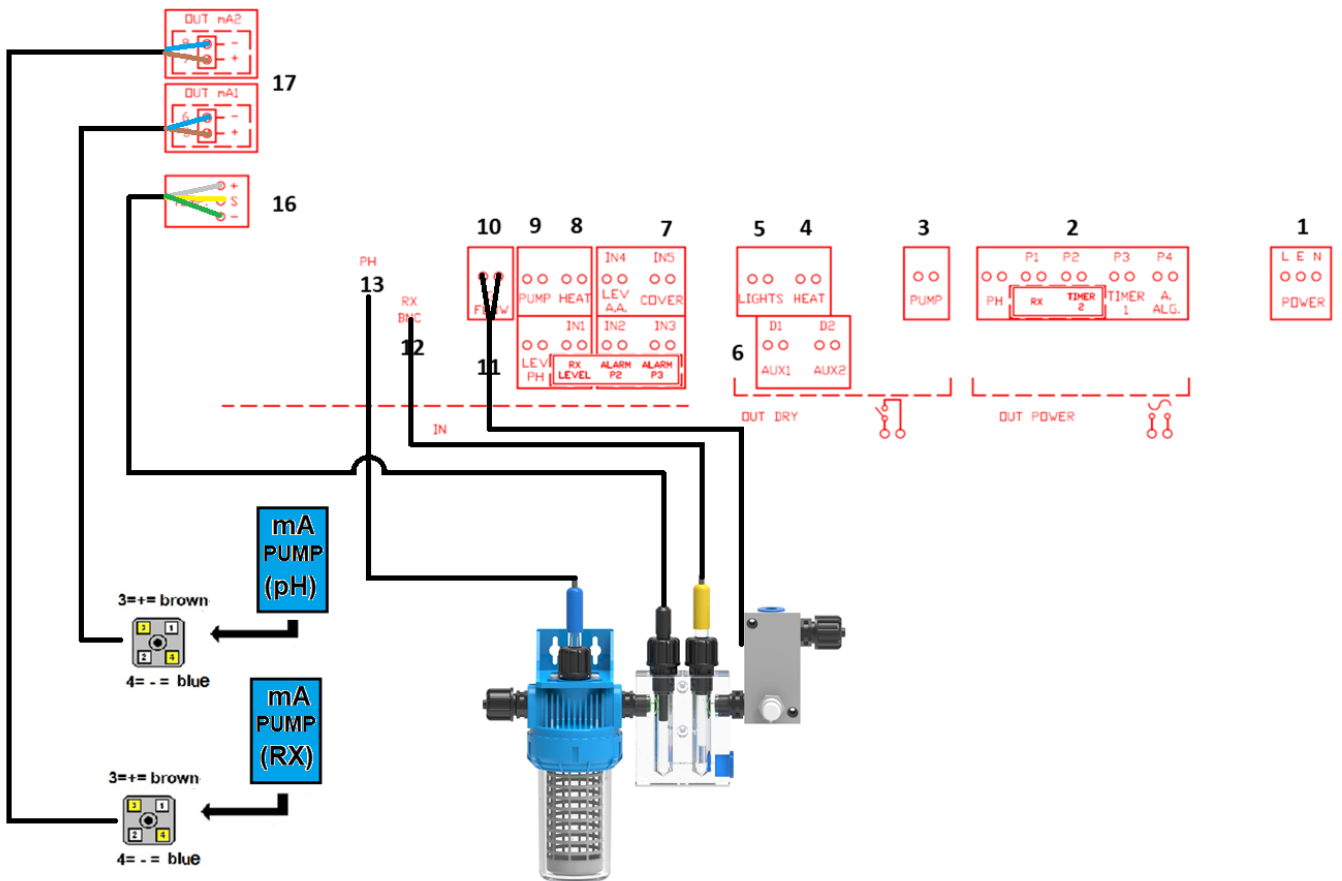

3.2.4.5. PH-CL CG CL3 mA PUMPS

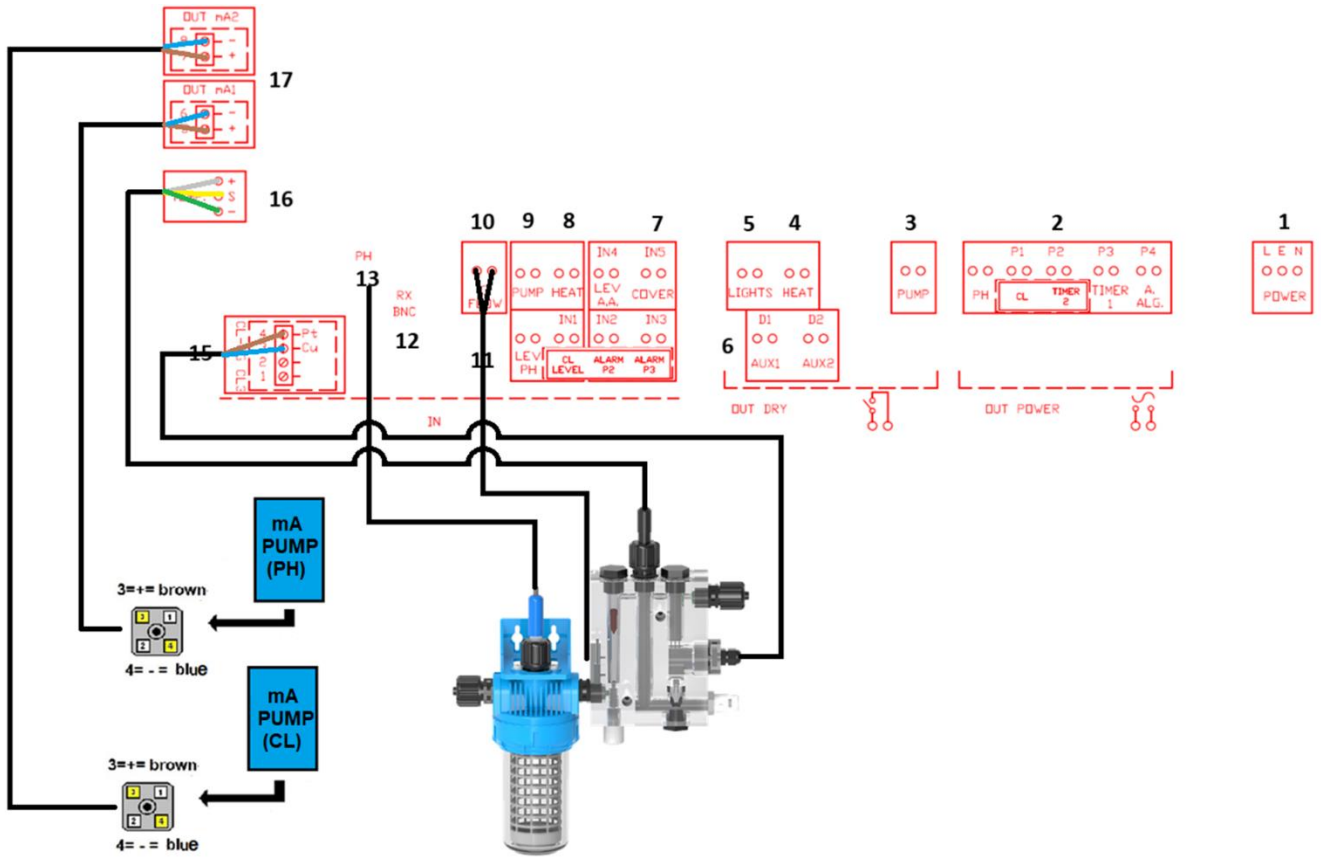

3.2.4.6. PH-CL CP mA PUMPS

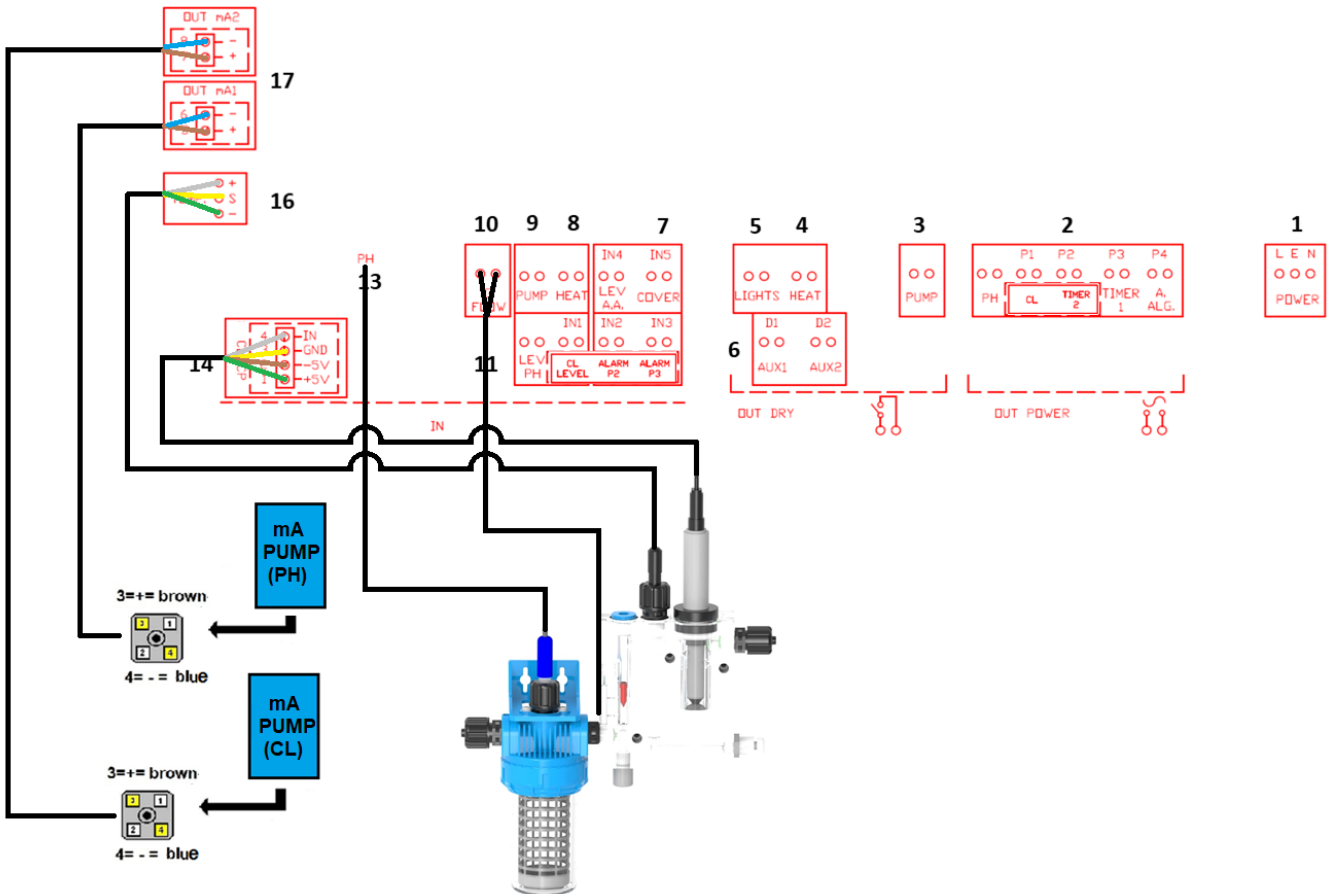

4. PROGRAMMING THE CONTROL UNIT

4.1. HOME PAGE: REAL-TIME INFORMATION

Connect MICRODOS POOLTEC to a mains socket, wait until the screen starts up (**IT MAY SOMETIMES BE NECESSARY TO WAIT A FEW MINUTES**). Once the system has started up, the first thing you will see is HOME PAGE, from which you can operate the **touch-screen's** buttons. The system is pre-programmed at the factory. However, if you do not need to do any additional programming, you need merely to press the **AUTO** key, and Microdos Pooltec will function using the programs as set (defaults, see DEFAULT CONFIGURATION page 49).



By using the  button, *from navigation at any time*, you will access the HOME page.

System status. The system will tell you if all is well, or if there is any error.

Information on pump programming.

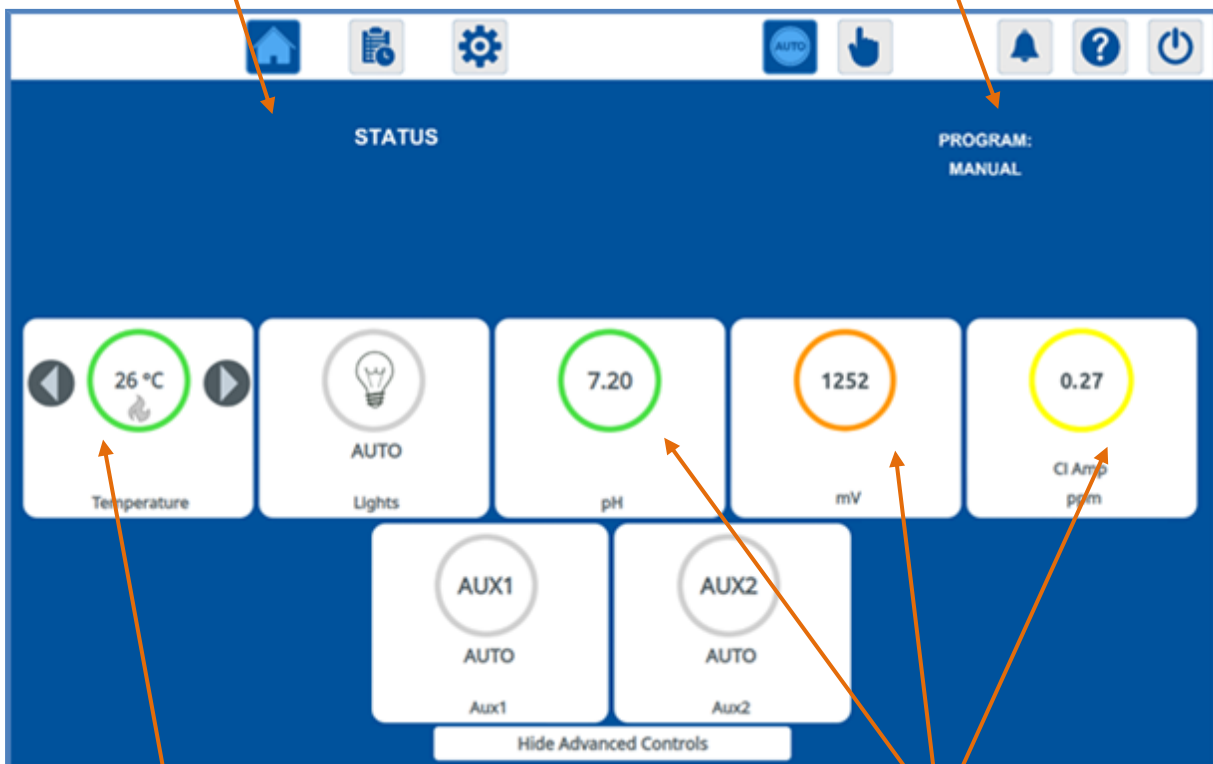

Real-time values for:
- Temperature





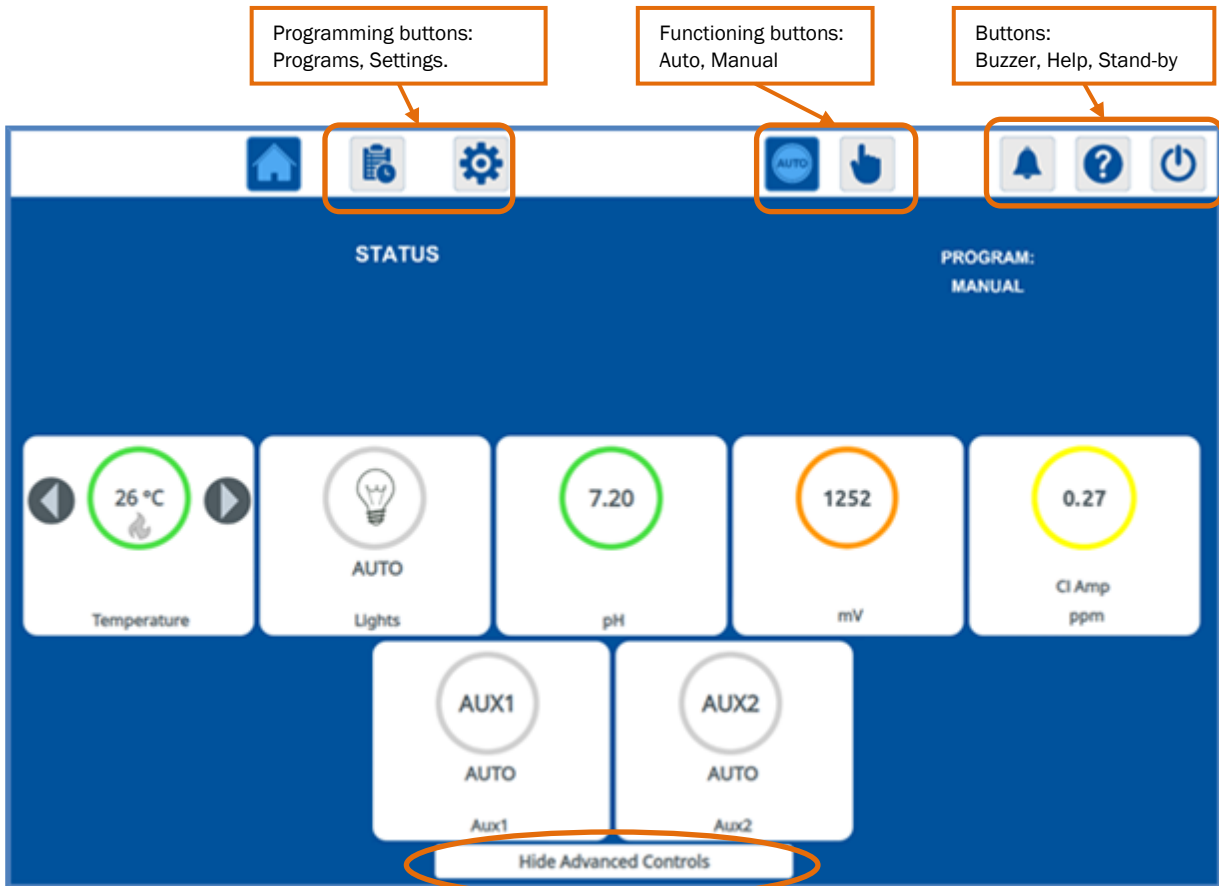



Real-time values for:
pH, Redox, Chlorine.
- GREEN: EXCELLENT VALUE
- YELLOW: GOOD VALUE
- ORANGE: VALUE TO BE MONITORED

4.2. ICONS



By pressing the "HIDE ADVANCED CONTROLS" button, you can minimise the second row to display information about the IDN/MODEL/TIME.



	HOME PAGE	Real-time values for the various measurements. System status & Information on pump programming.
	PROGRAMS	Access to configure the working programs for recirculation pump.
	SETTINGS	Access to configure the device settings for measurements, outputs, and operations.
	AUTO	In AUTO MODE, the system will work automatically in accordance with the operating program, settings and set points entered. When working in Auto Mode, the Home Page background colour is BLUE.
	MANUAL	Inside the MANUAL PAGE, you can manually manage the device and activate/deactivate all the OUTPUTS. When working in Manual Mode, the Home Page and Manual Page background colour is YELLOW.
	BUZZER	If there is a fault of any kind, visual and audible alarms will be activated. To silence the audible alarm, press the BUZZER button. The SYSTEM STATUS window in the Home Page will show the alarm.
	HELP	If you need help while configuring the system, you can consult the help menu on your device. Display a help page with a description of the elements in the current page.
	STAND-BY	Put the control unit in stand-by mode. All the operations are stopped but the measures are still displayed. To shut down the system, you need to unplug the power supply.

4.3. AUTO FUNCTIONING



By using the  button, the system will work automatically in accordance with the operating program, settings and set-points entered.

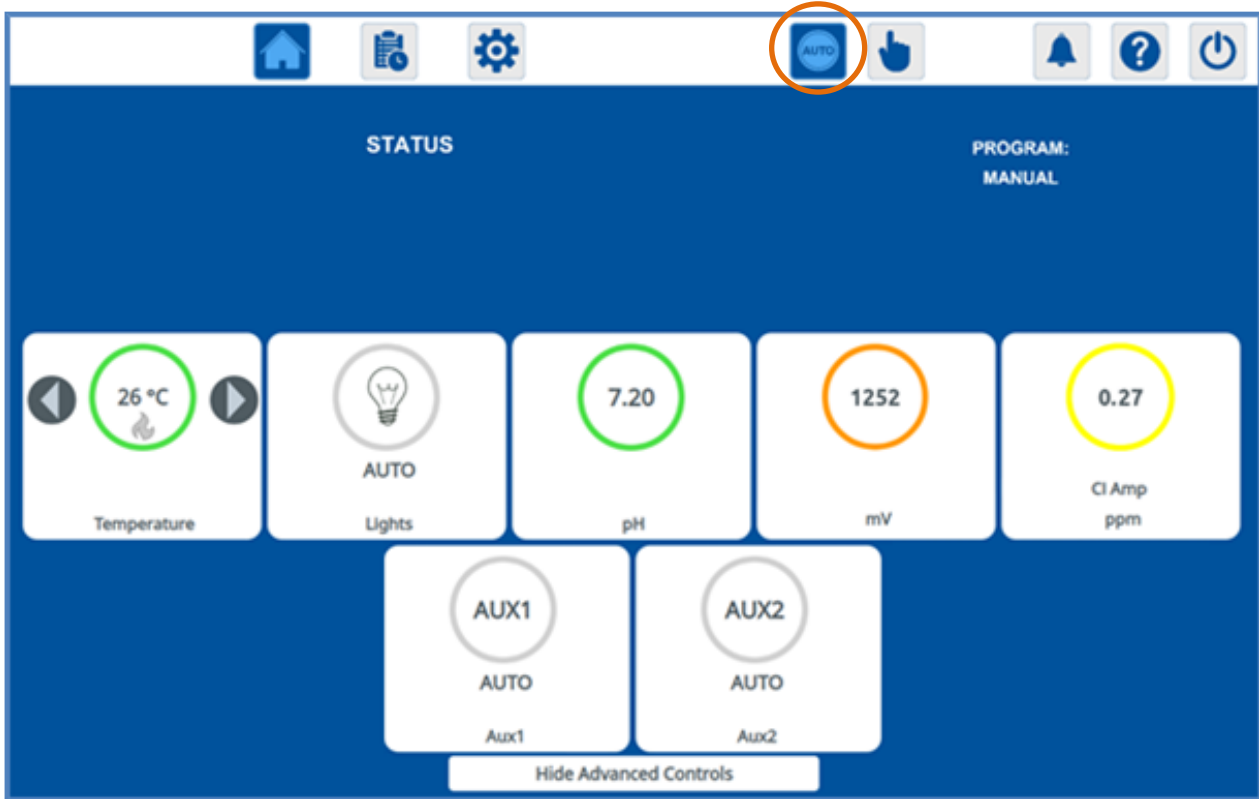

NOTE:



When working in Automatic Mode, the Home Page background colour is BLUE.

4.4. MANUAL FUNCTIONING

By using the  button, from navigation at any time, you will access the MANUAL page.

From this page you can display the real-time state of the inputs and outputs of the device and **simply by a touch you can activate and deactivate an output (PUMP, HEAT, pH pump, etc.)** for example for priming.

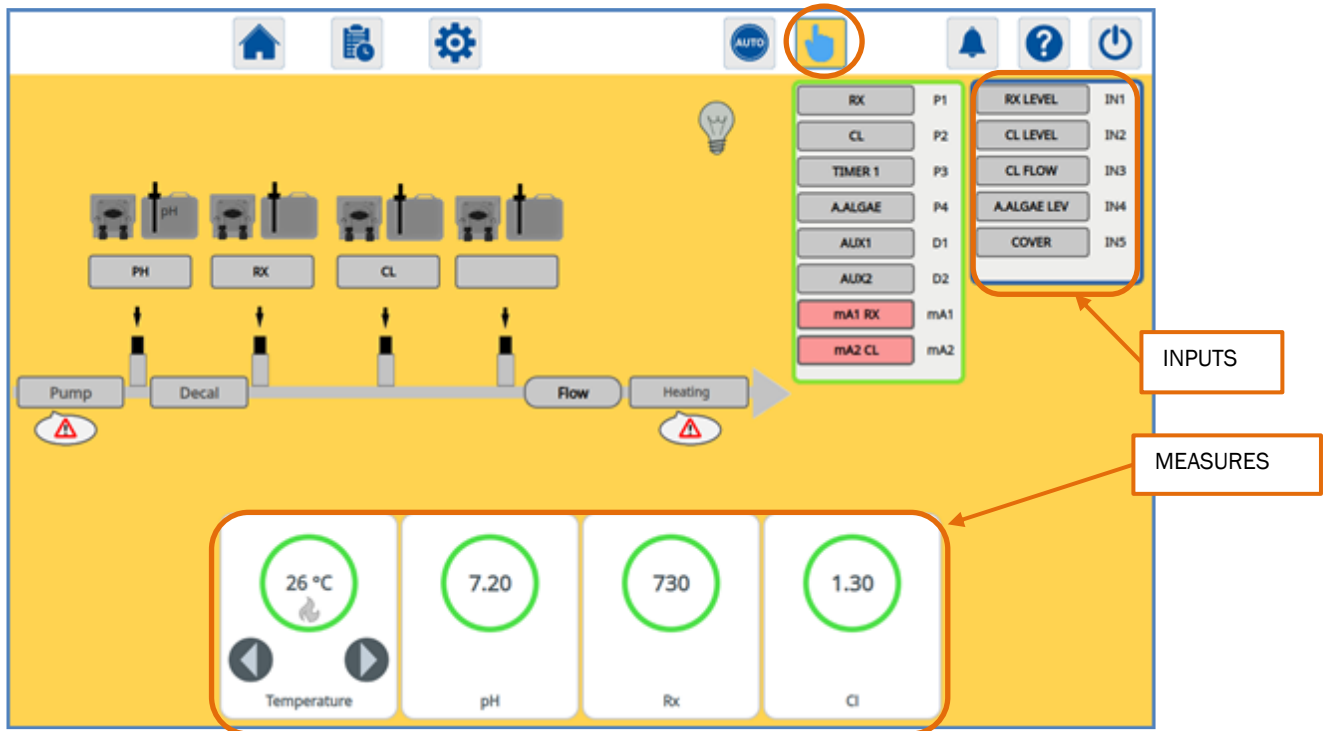

NOTE:



THIS PAGE CAN BE FREELY CONFIGURED BY THE INSTALLER (INSTALLER PASSWORD NEEDED) TO BE VERY SIMILAR TO THE REAL PLANT (see INSTALLER reference).

IF YOU WANT TO GO BACK TO AUTO FUNCTIONING, TOUCH  to return the system into automatic operation (MANUAL PAGE background colour turns WHITE and HOME PAGE background colour turns to BLUE).

IF YOU WANT TO GO BACK TO HOME PAGE, TOUCH  . YOU WILL SEE THE HOME PAGE BACKGROUND COLOUR IN YELLOW.

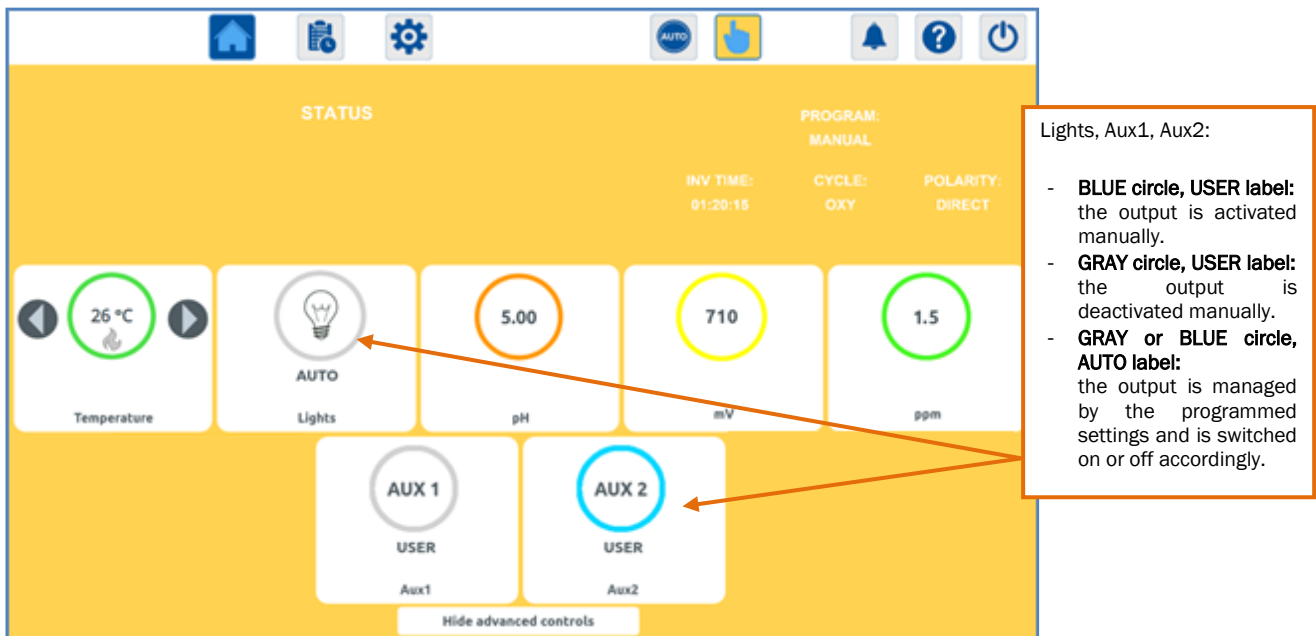

When the background of the page is yellow, with a short press inside the Lights, Aux1 and Aux2 circle, you can choose to manually manage these outputs. If you do not touch these circles, the output will continue to follow the automatic functioning.

4.5. PROGRAMMING THE SYSTEM

To configure the various function of MICRODOS POOLTEC, you can access the programming in 2 different ways:

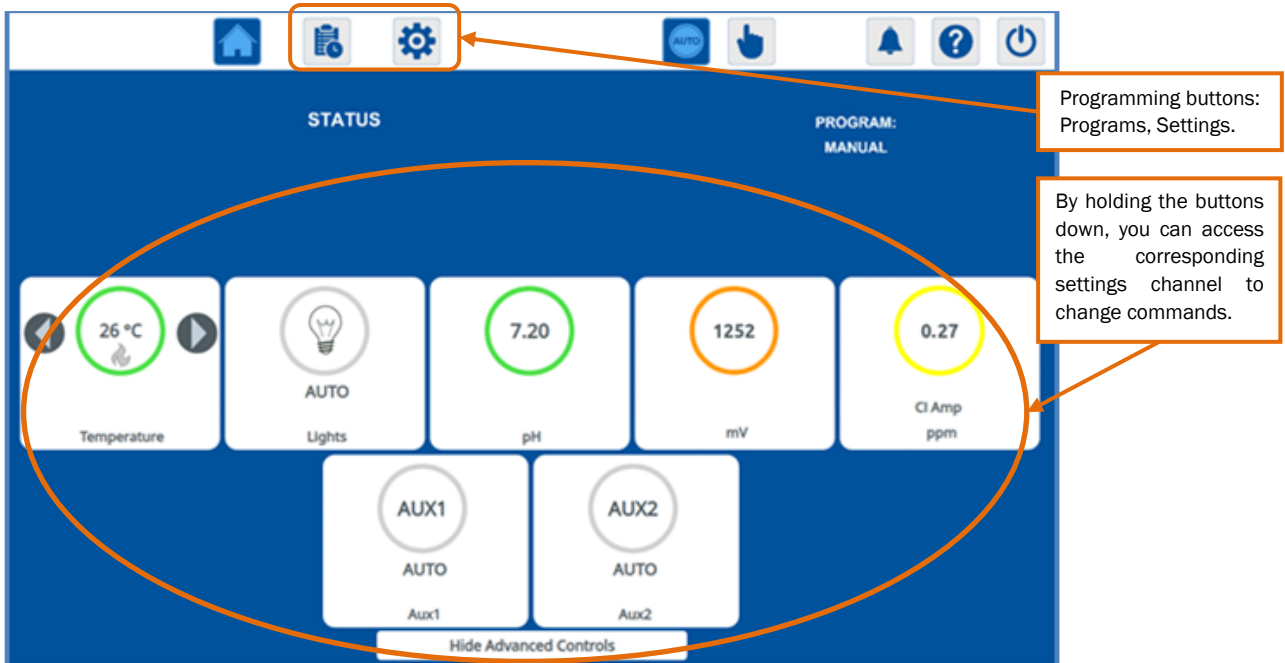

4.5.1 PASSWORD

If you attempt to access the EXPERT programming, you need to enter **password 11222**.



4.5.2. PROGRAMS: PROGRAMMING RECIRCULATION PUMP

Change the recirculation pump programs by pressing the icon. The following window will appear.

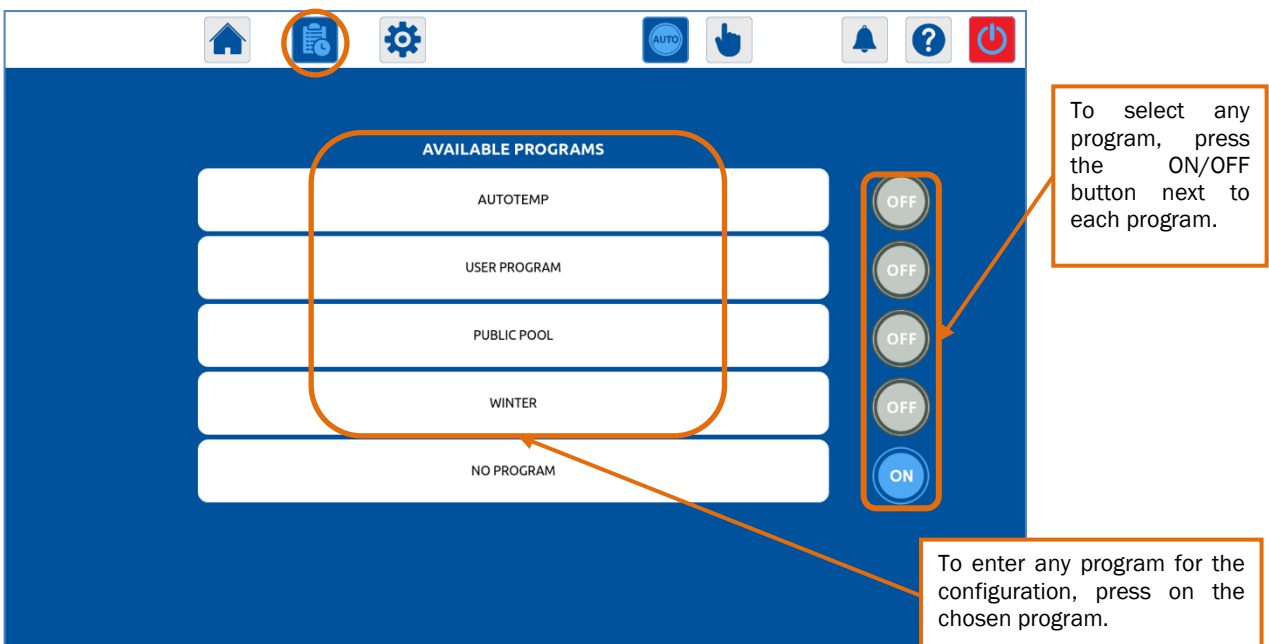

There are five possible operating programs for the recirculation pump.

AUTOTEMP	Operation will depend on the water temperature. The system measures the water temperature after 2 minutes from the filtration beginning and automatically calculates the operating time of the pump. These times are recalculated every 30 minutes based on the water temperature.
USER	The user can program up to 3 daily timers for the activation of the recirculation pump.
PUBLIC POOL	The recirculation pump is factory set for 24 hours a day.
WINTER	The user can program up to 3 daily timers for the activation of the recirculation pump. It is possible to set a water frost protection.
NO PROGRAM	There is no program for the activation of the recirculation pump. Heating cannot work.



NOTE: if you need help while configuring the various programs, please consult the help menu on your device.

PROGRAMS

4.5.2.1. AUTOTEMP:

Operation will depend on the water temperature:

the number of hours of operation of the recirculation pump is half of °C (for example if the temperature detected is 26 °C the pump will be on for 13 hours).

NOTE:



1. To activate the program:
 - With a short press on the day, you access in the settings for the selected day.
 - With a second short press on the day, the program is activated on that day (blue colour).
 - If you wish to use the daily program already set, copy it for the entire week by pressing SET ALL WEEK.
2. Weekdays colour:
 - a. BLUE: the program is active on the day.
 - b. GREY: the program is not active on the day.
3. Always press SAVE to make the modification effective.
4. Pump On "00:00" → no programming

BASIC MENU:

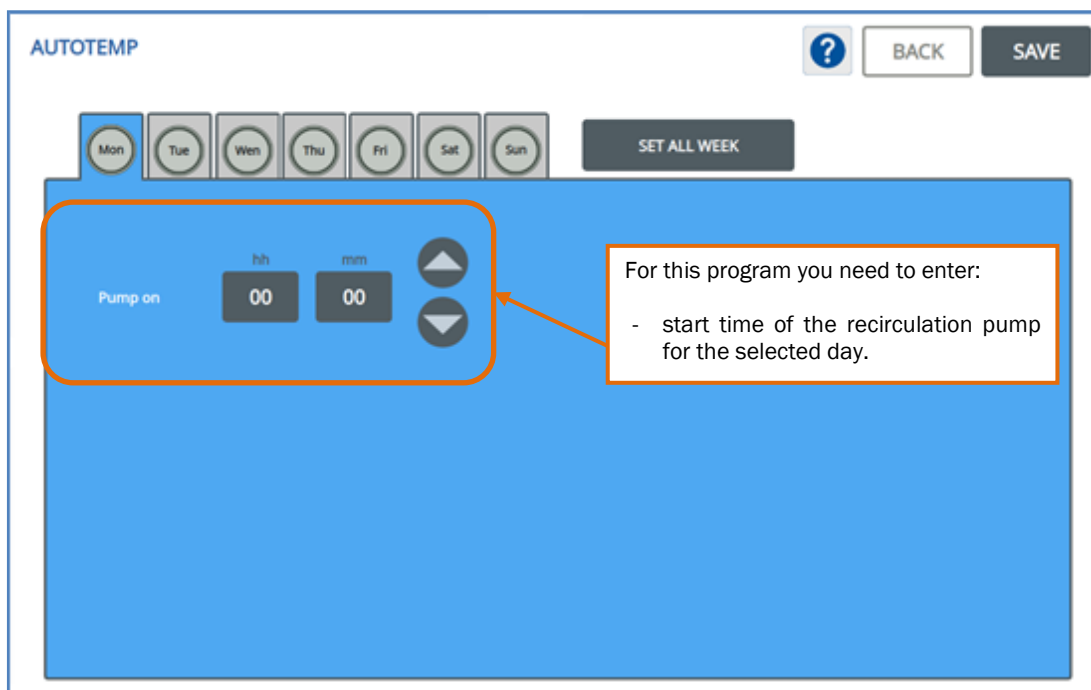

4.5.2.2. USER PROGRAM

Configure up to 3 daily timers to program the activation of the recirculation pump.

NOTE:



1. To activate the program:
 - With a short press on the day, you access in the settings for the selected day.
 - With a second short press on the day, the program is activated on that day (blue colour).
 - If you wish to use the daily program already set, copy it for the entire week by pressing SET ALL WEEK.
2. Weekdays colour:
 - a. BLUE: the program is active on the day.
 - b. GREY: the program is not active on the day.
3. Always press SAVE to make the modification effective.
4. Values of On at "00:00" and Off at "00:00" → no programming

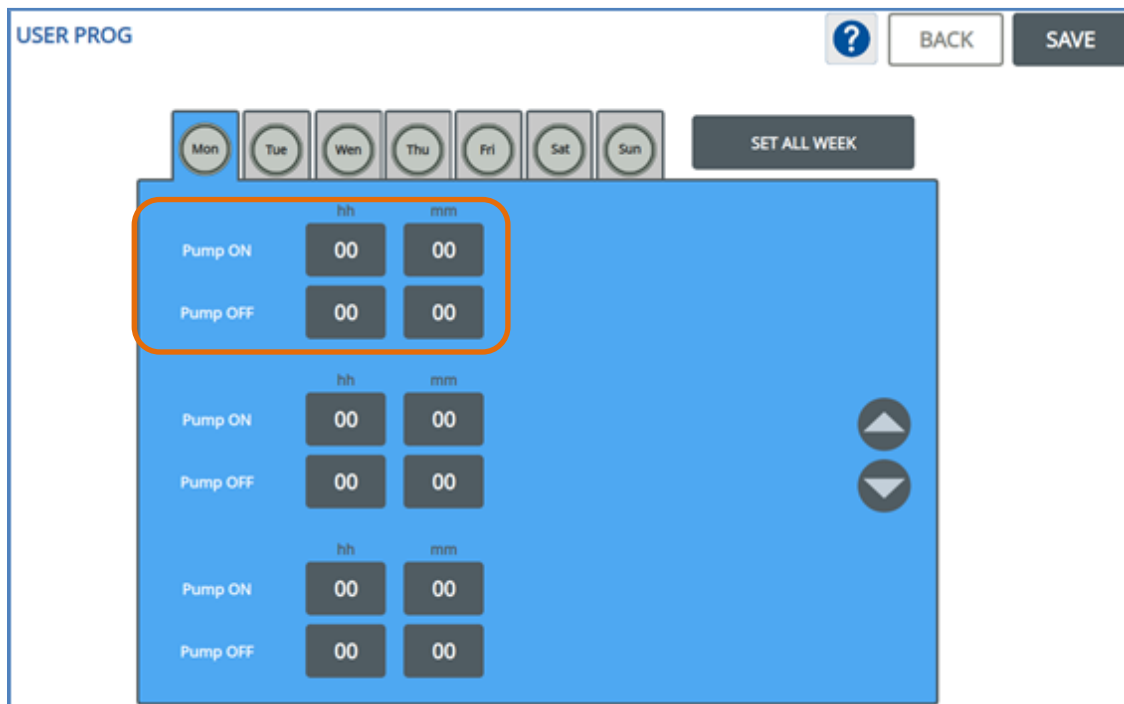

4.5.2.3. PUBLIC POOL

Keep the recirculation pump on 24 hours a day.

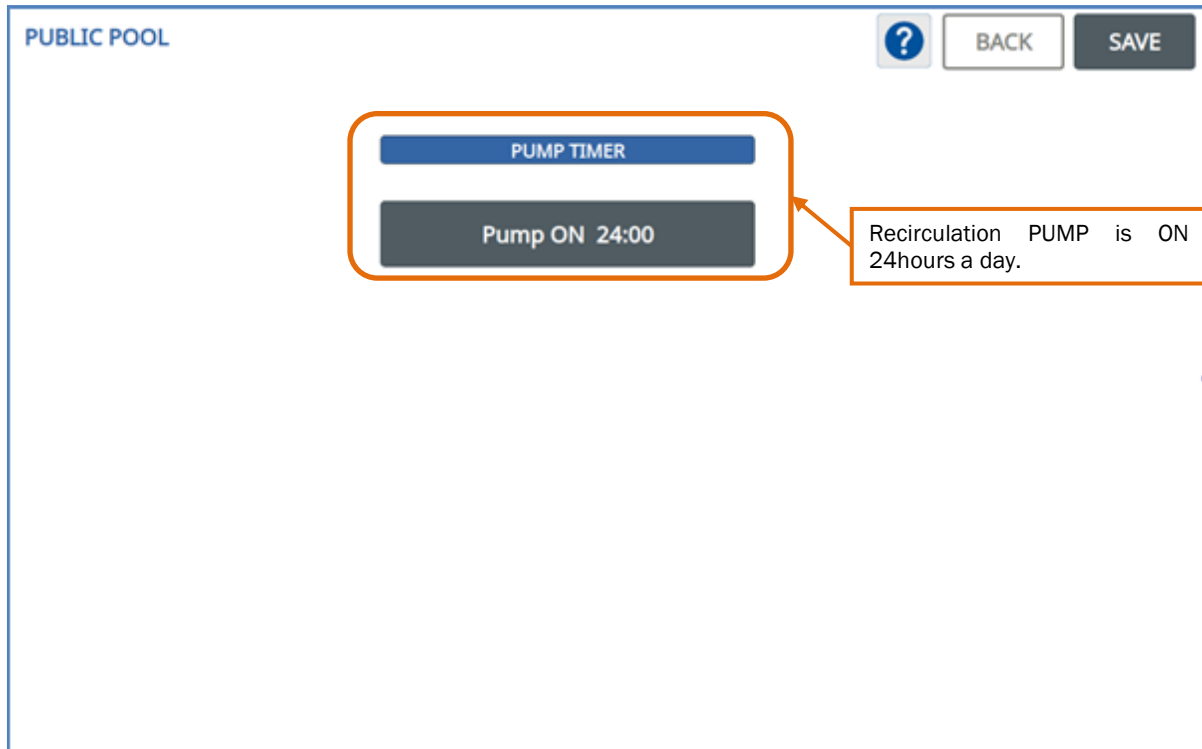

NOTE:



Always press SAVE to make the modification effective.

4.5.2.4. WINTER

NOTE: Only the recirculation pump works.

Configure up to 3 daily timers to program the activation of the recirculation pump.



1. To activate the program:
 - With a short press on the day, you access in the settings for the selected day.
 - With a second short press on the day, the program is activated on that day (blue colour)..
 - If you wish to use the daily program already set, copy it for the entire week by pressing SET ALL WEEK.
2. Weekdays colour:
 - a. BLUE: the program is active on the day.
 - b. GREY: the program is not active on the day.
3. Always press SAVE to make the modification effective.
4. Values of On at "00:00" and Off at "00:00" → no programming on recirculation pump

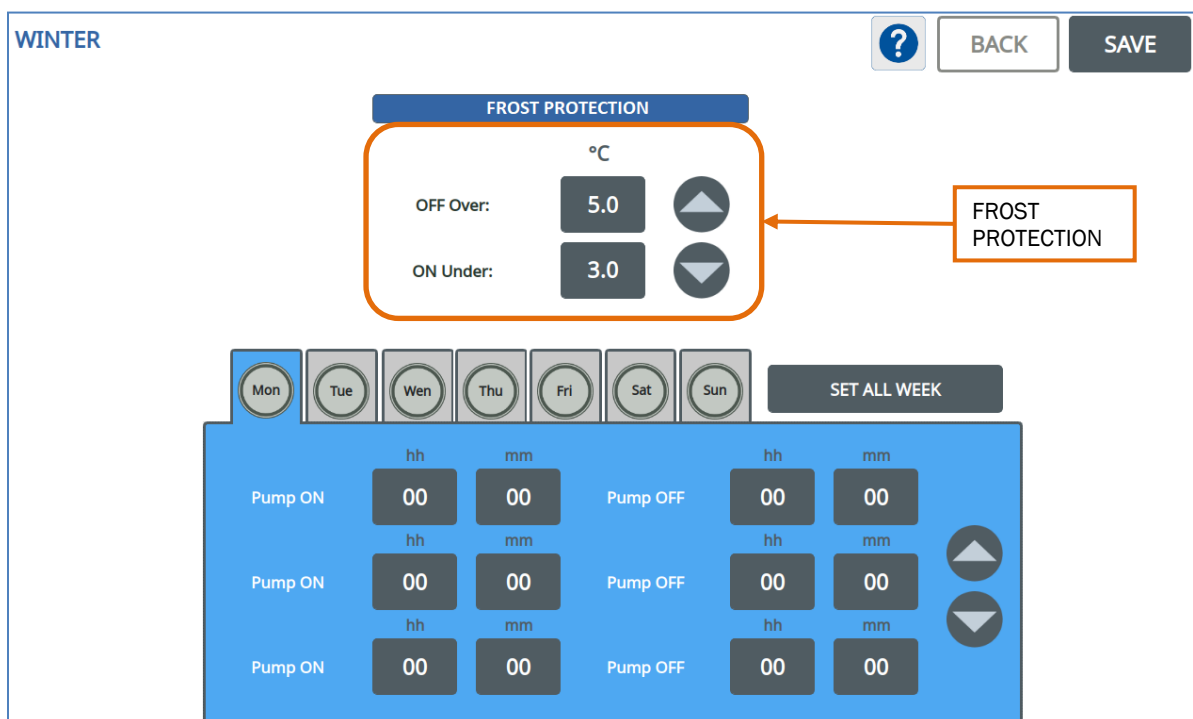

FROST PROTECTION:

Set the minimum and maximum water temperature for the frost protection function.

The pump is activated during no-working periods, every hour for 10 minutes and the water temperature is monitored. If the temperature is below the ON under value, the pump continues to work until it reaches the OFF over temperature.

4.5.3. SETTINGS

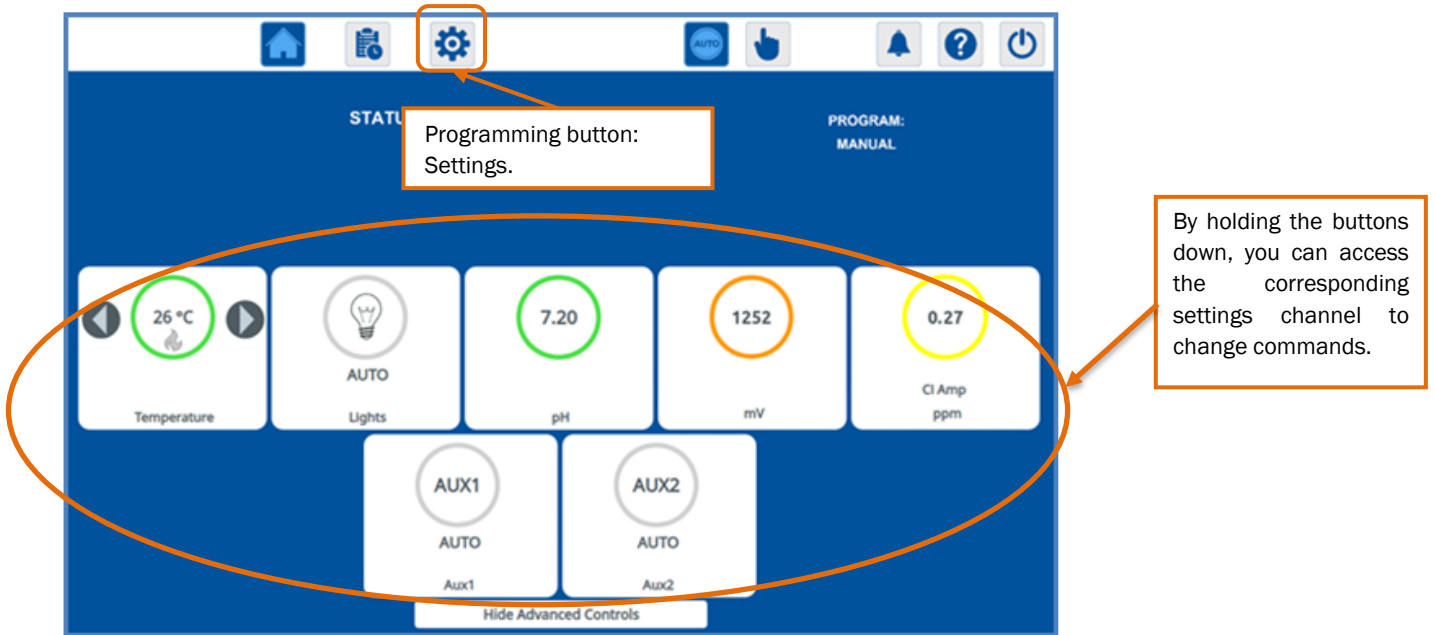

When you access the Settings Menu, you can find 2 different sub-menus:

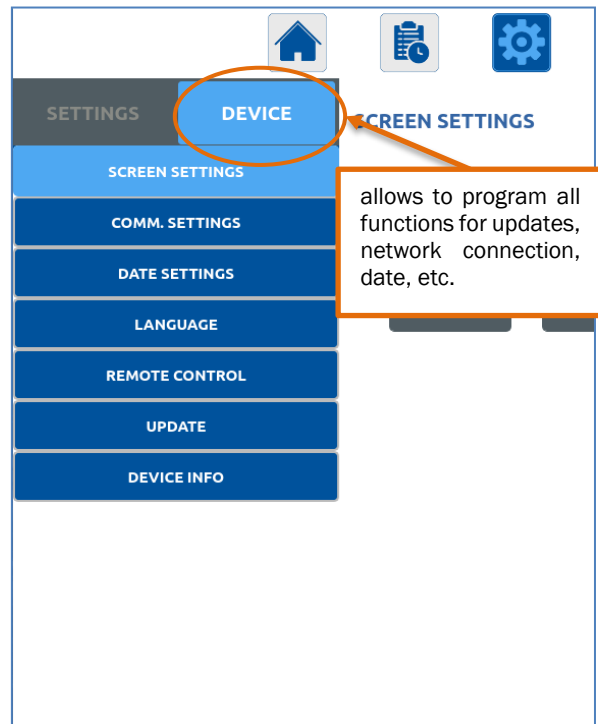
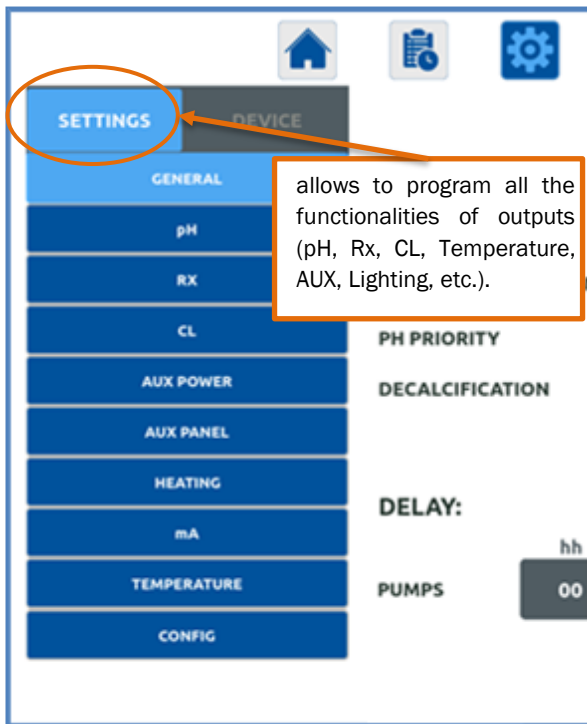

SETTINGS

4.5.3.1. MODIFY PARAMETERS VALUE

NOTE: It is possible to edit all the numeric values inside the boxes.



1. Press on the box of the value you wish to modify.
2. Modify using the arrows.
3. Always press SAVE to make the modification effective.
4. Value on "00:00" → no programming

4.5.3.2. GENERAL:

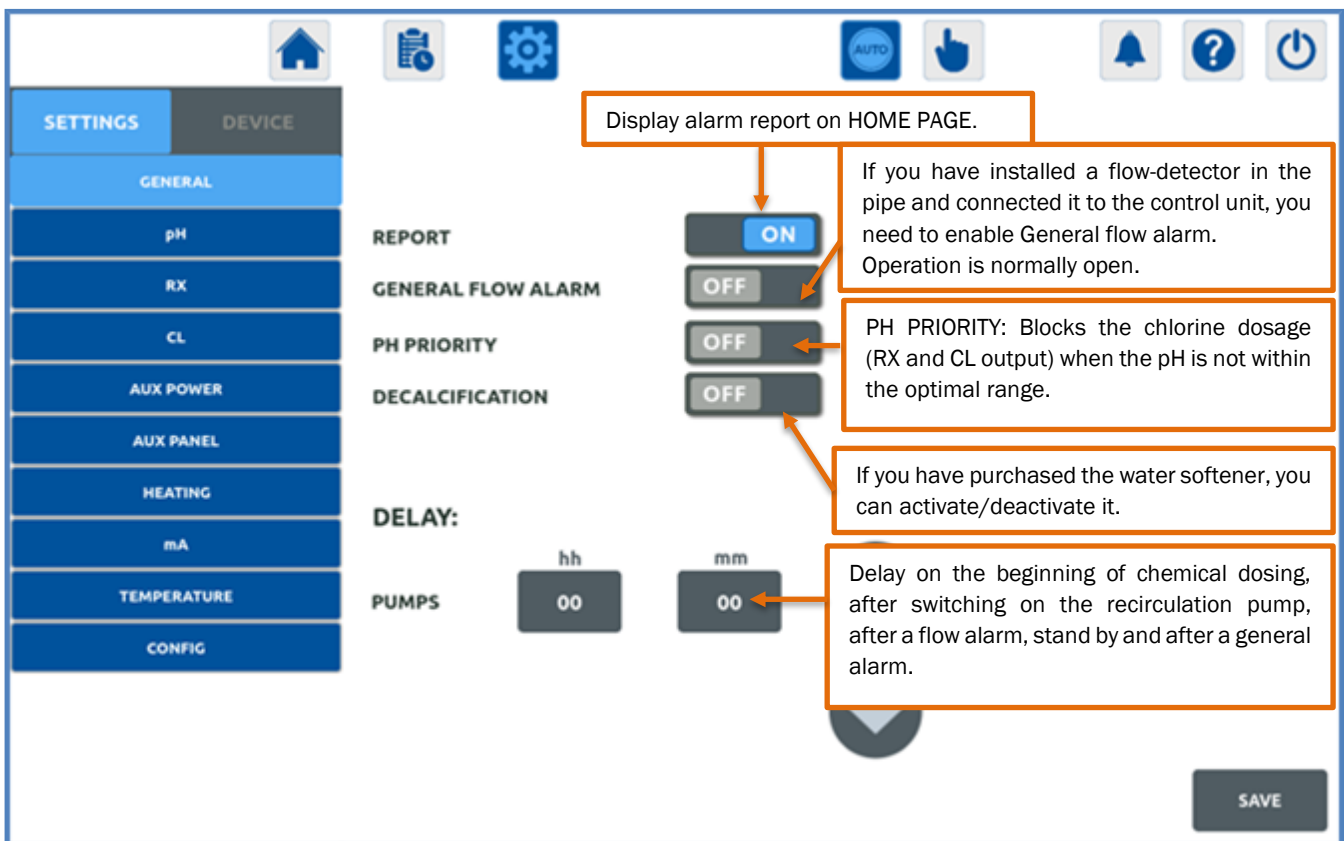

4.5.3.2.1. GENERAL FLOW ALARM

The flow sensor must be wired to poles 10 of the main board (see page 11).
Depending on the model, it is possible to have 2 different cables:

- a pair of black cables
- a pair of brown and black cables

Flow alarm operation is normally open.

VERY IMPORTANT NOTE:

If in  menu “NO PROGRAM” is ON, the recirculation pump is independent from POOLTEC and in case of a flow alarm on POOLTEC, this will stop dosing and all the outputs dependent on water flow.

If in  menu a program is active (AUTOTEMP, USER PROGRAM, PUBLIC POOL, WINTER), the recirculation pump is driven from POOLTEC and in case of a flow alarm, POOLTEC will stop the recirculation pump.
To esc from this alarm you need to check the recirculation plant to solve the problem and then, when you want to restart the pump, you need to deactivate GENERAL FLOW ALARM (OFF→SAVE), wait for a while and when the recirculation pump is running you can activate GENERAL FLOW ALARM again (ON→SAVE).

NOTE: to apply the changes it is always necessary to press the **SAVE** button.

4.5.3.3. MEASUREMENT (PH, RX, CL) FUNCTION (BASIC/EXPERT)

By pressing the measure button, a window like this will appear:

Annotations for the PH HOME interface:

- Visualization in the home page. (Points to the PH HOME header)
- Enables/disables the chemical dosing. (Points to the PH OUTPUT ON/OFF toggle)
- Setpoint – desired value. No dosing. (Points to the 7.20 pH setpoint)
- Maximum Threshold. Maximum dosing. (Points to the 8.20 pH maximum threshold)
- MEASURE VALUE (Points to the 6.8 pH measurement)
- Date of the last calibration and button to calibrate test-probe. (Points to the 00/00/0000 date and CALIBRATE button)
- Access a menu with more complex settings. **Expert PASSWORD required.** (Points to the EXPERT button)

By pressing the EXPERT button, this window will appear:

Annotations for the EXPERT settings interface:

- OVERDOSE:** maximum dosing time alarm. If you wish to dose a specified quantity of chemical, you can set a maximum daily dosing time. When the set time is reached, the alarm stops the dosing.
- OVERDOSE LIMIT:** maximum dosing time alarm with measure below LOW or above HIGH. When the set time is reached, the alarm stops the dosing.
- Value "00:00" → no programming**
- Information about the probe:
 - Real physical input
 - information about last probe calibration.
- Factory Reset of parameters or calibrations related to the displayed measurement. **Expert PASSWORD required.**
- Turn off the Overdose or Overdose Limits alarm and restores the chemical dosing. (Points to the Reset Alarms button)



NOTE: To make effective the expert settings, press SAVE before pressing HIDE.

4.5.3.4. PROBES CALIBRATION

4.5.3.4.1. CALIBRATING THE PH PROBE

1. Press the **STAND-BY**  button.
2. Unscrew the probe holder base, take out the pH probe and insert it into buffer solution pH7 (supplied with the system).
3. With the probe in the 7pH solution, wait for the stabilization of the measurement. Once the measure is stable,
4. Press the “**Calibrate**” button inside the pH settings menu.
5. Insert the EXPERT PASSWORD (11222) to enter the calibration procedure.
NOTE: it is possible to exit from the calibration procedure simply pushing “CANCEL.”
6. When “Read value” is stable hit **OK**. You will hear a beep when you press OK (to communicate that the measurement is recorded).
7. Remove the probe from the buffer solution pH7, clean it with a little water.
8. Insert the probe in the buffer solution pH9 (supplied with the system), wait for the stabilization of the measurement. Once the measure is stable hit **OK**.

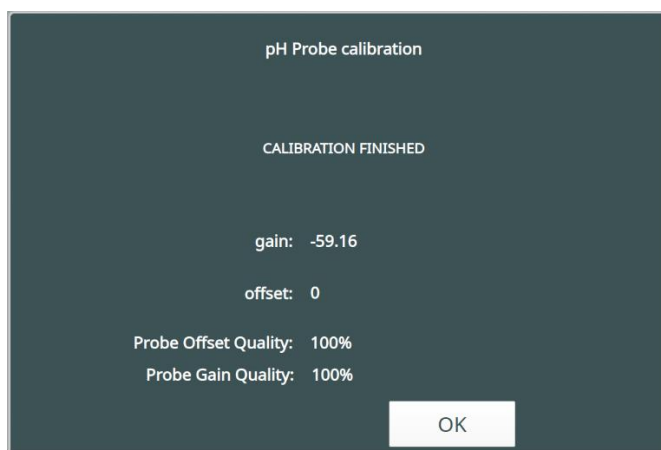

9. A window with the values of OFFSET and GAIN obtained from the calibration and the PROBE QUALITY CONTROL will appear.
100% = Excellent probe
50% = Good probe to be monitored
25% = probe that you should change
0% = fully exhausted probe

IF THE PROBE QUALITY IS LESS THAN 25%, PLEASE REPEAT CALIBRATION PAYING ATTENTION TO THE VALUES OF BUFFER SOLUTION. IF THE CALIBRATION GIVES THE SAME RESULTS CONTACT YOUR INSTALLER.

10. Press **OK** to return to the pH MENU. The “**Last Calibration**” box will be updated to the current date.
11. Insert the probe into the probe holder again and screw the probe holder base.

NOTE: follow next step, only if you do not have to calibrate RX probe.

12. On device, press the **STAND-BY**  button to return to the working mode, and press the **AUTO** button so that our system will now operate applying the new calibration.

4.5.3.4.2. CALIBRATE THE RX PROBE

1. Press the **STAND-BY**  button.
2. Unscrew the probe holder base, take out the RX probe and insert it into buffer solution 468mV (supplied with the system).
3. With the probe in the 468mV solution, wait for the stabilization of the measurement. Once the measure is stable,
4. Press the **“Calibrate”** button inside the RX settings menu.
5. Insert the EXPERT PASSWORD (11222) to enter the calibration procedure.
NOTE: it is possible to exit from the calibration procedure simply pushing “CANCEL.”
6. When reading is stable hit **OK**.

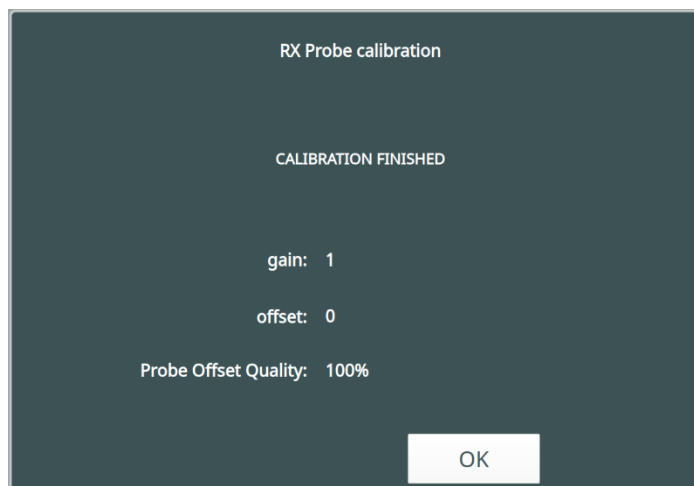

7. A window with the values of OFFSET obtained from the calibration and the PROBE QUALITY CONTROL will appear.
Quality of the Offset of the RX probe:

100% = Excellent probe
50% = Good probe to be monitored
25% = probe that you should change
0% = fully exhausted probe

IF THE PROBE QUALITY IS LESS THAN 25%, PLEASE REPEAT CALIBRATION PAYING ATTENTION TO THE VALUES OF BUFFER SOLUTION. IF THE CALIBRATION GIVES THE SAME RESULT CONTACT YOUR INSTALLER

8. Press **OK** to return to the RX MENU. The **“Last Calibration”** box will be updated to the current date.
9. Insert the probe into the probe holder again and screw the probe holder base.
10. On device, press the **STAND-BY**  button to return to the working mode, and press the **AUTO** button so that our system will now operate applying the new calibration.

4.5.3.4.3. CALIBRATE THE AMPEROMETRIC CHLORINE PROBE

NOTE:



- it will be necessary to do a comparative free chlorine test (e.g., a DPD1 photometric test).
- ZERO CALIBRATION is factory performed then it is not possible.
- Only GAIN CALIBRATION is possible.

GAIN CALIBRATION

RECOMMENDATIONS: before doing GAIN calibration, PAY ATTENTION TO THE FOLLOWING INSTRUCTIONS:

1. It is necessary to stabilize the water flow by turning the knob regulation till the floater stays in the upper position (60l/h). This is important because the right water flow rate allows the glass spheres to clean adequately the copper surface.
2. Before calibrating the GAIN of the chlorine probe, stabilize the pH at the working conditions. (We recommend choosing a value from 7.0 to 7.3pH).
3. It is necessary to do the Chlorine gain calibration at concentration values nearest possible to the desired setpoint. For example, if the chlorine concentration desired is 1.20ppM it is strictly recommended to do the gain calibration with water in those conditions. Use a DPD1 photometric test to check the chlorine concentration in the water sample taken from the Tap (see the figure here below).

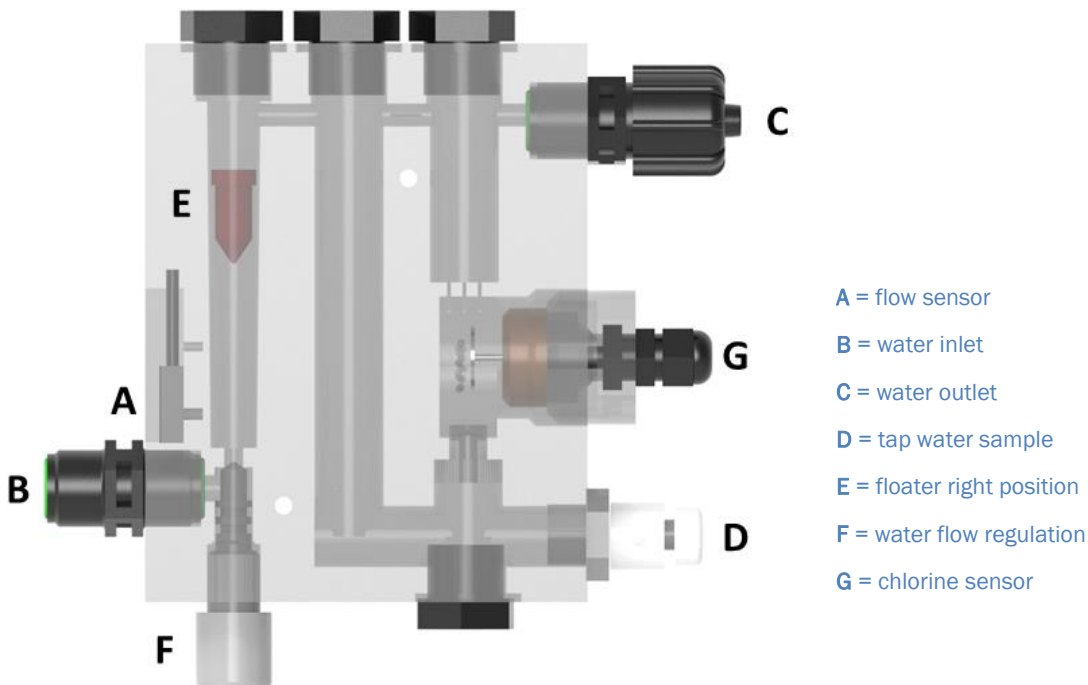

It is recommended to do the gain calibration after at least 2 or 3 hours of optimal working conditions, or alternatively it is possible to do a first gain calibration after having installed *Microdos Pooltec* and the probe in the plant and then perform the definitive calibration after 24 hours of working of the probe.

After having stabilized the flow and the pH and having stabilized the chlorine concentration at the optimal and desired value, wait for the stabilization of the reading on the *Microdos Pooltec* display.

TEST

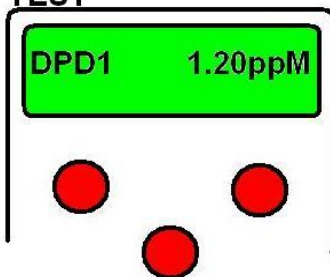

Do a DPD1 test on the water sample taken from the Tap of the probe holder (D).

On device:

1. Press the **"Calibrate"** button inside the CL settings menu.
2. Insert the EXPERT PASSWORD (11222) to enter the calibration procedure. The window will appear as the following:

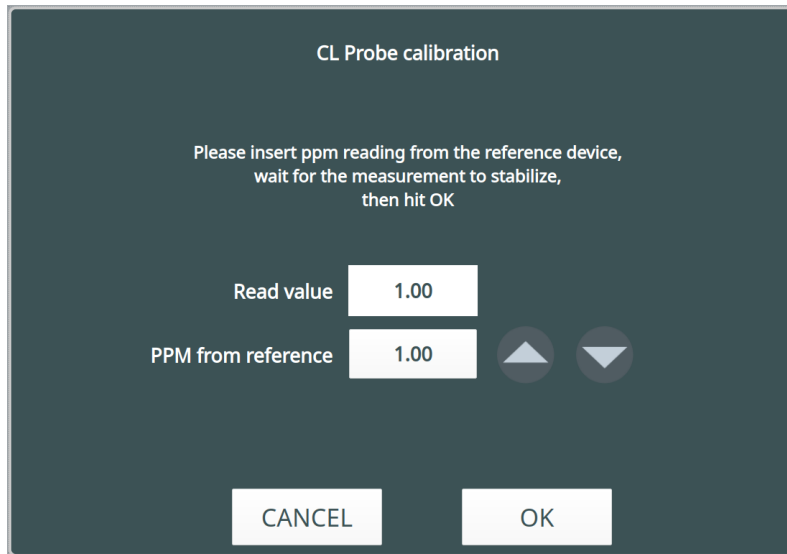

NOTE: it is possible to exit from the calibration procedure simply pushing "CANCEL."

3. Press the arrows ▲ ▼ to insert the value measured by the reference DPD1 test. Enter the right value then press OK.

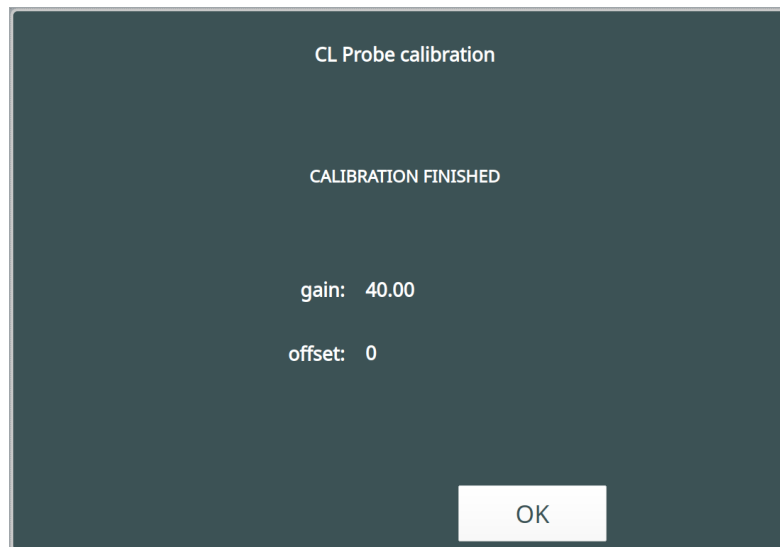

4. A window with the value of GAIN obtained from the calibration will appear.
5. Press **OK** to return to the CL menu. The **"Last Calibration"** box will be updated to the current date.

4.5.3.4.4. CALIBRATE THE POTENTIOSTATIC CHLORINE PROBE

NOTE:



- it will be necessary to do a comparative free chlorine test (e.g., a DPD1 photometric test).
- ZERO CALIBRATION is factory performed then it is not possible.
- Only GAIN CALIBRATION is possible.

GAIN CALIBRATION

RECOMMENDATIONS: before doing GAIN calibration, PAY ATTENTION TO THE FOLLOWING INSTRUCTIONS:

1. It is necessary to stabilize the water flow by turning the knob regulation till the floater stays in the upper position (60l/h).
2. Before calibrating the GAIN of the chlorine probe, stabilize the pH at the working conditions. (We recommend choosing a value from 7.0 to 7.3pH).
3. It is necessary to do the Chlorine gain calibration at concentration values nearest possible to the desired setpoint. For example, if the chlorine concentration desired is 1.20ppM it is strictly recommended to do the gain calibration with water in those conditions. Use a DPD1 photometric test to check the chlorine concentration in the water sample taken from the Tap (see the figure here below).

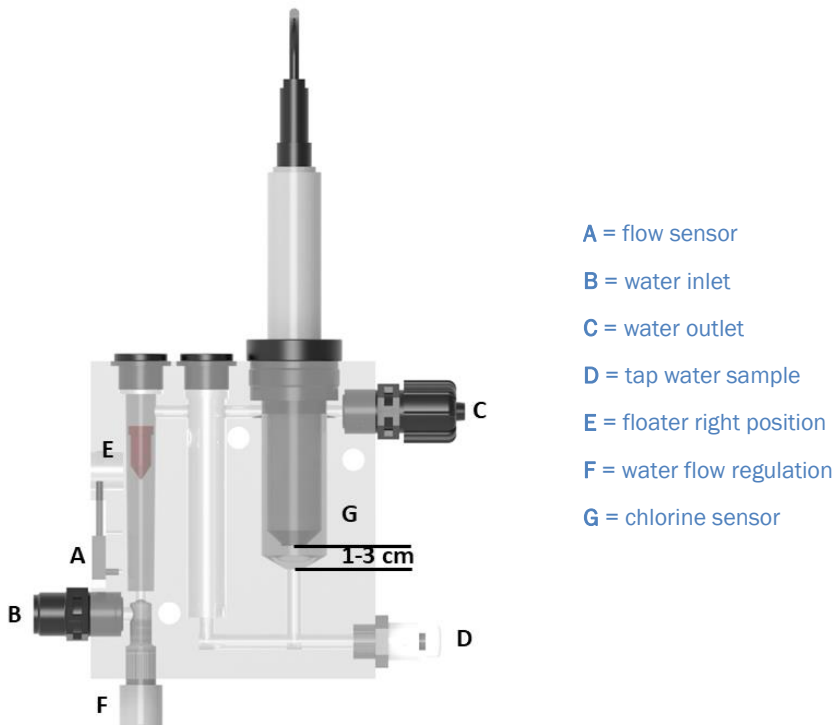

It is recommended to do the gain calibration after at least 2 or 3 hours of optimal working conditions, or alternatively it is possible to do a first gain calibration after having installed *Microdos Pooltec* and the probe in the plant and then perform the definitive calibration after 24 hours of working of the probe.

After having stabilized the flow and the pH and having stabilized the chlorine concentration at the optimal and desired value, wait for the stabilization of the reading on the *Microdos Pooltec* display.

TEST

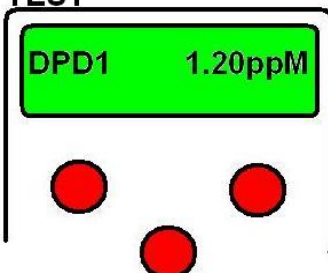

Do a DPD1 test on the water sample taken from the Tap of the probe holder (D).

On device:

1. Press the **“Calibrate”** button inside the CL settings menu.
2. Insert the EXPERT PASSWORD (11222) to enter the calibration procedure. The window will appear as the following:

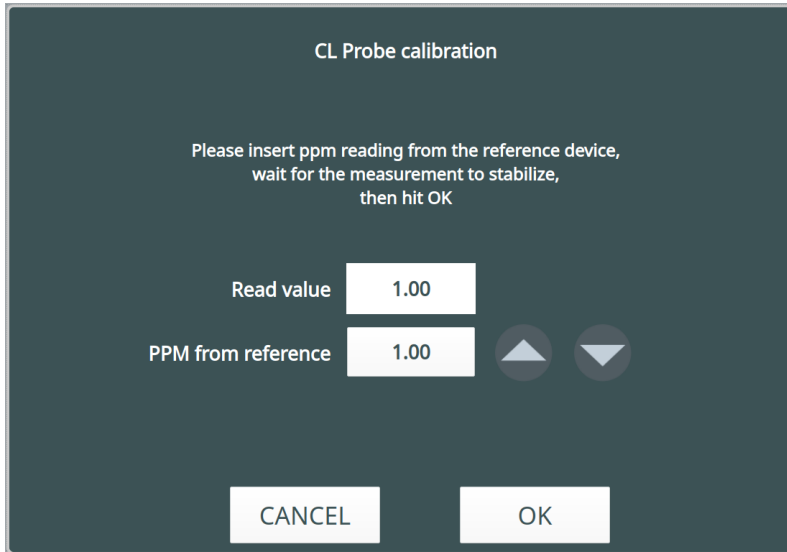

NOTE: it is possible to exit from the calibration procedure simply pushing “CANCEL.”

3. Press the arrows ▲▼ to insert the value measured by the reference DPD1 test. Enter the right value then press OK.
4. A window with the value of GAIN obtained from the calibration will appear.

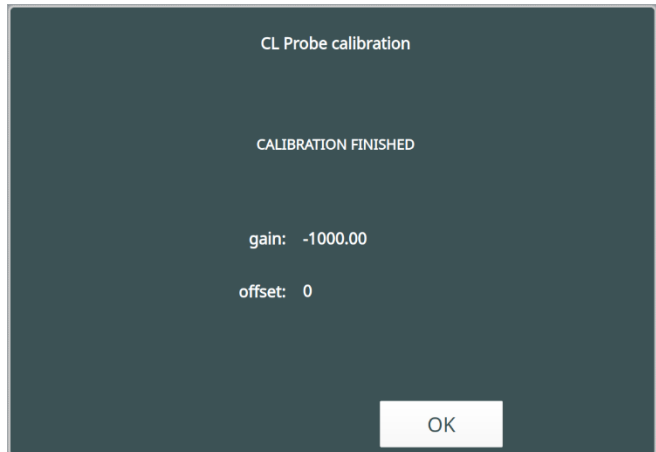

For CL_PB the gain value will be:

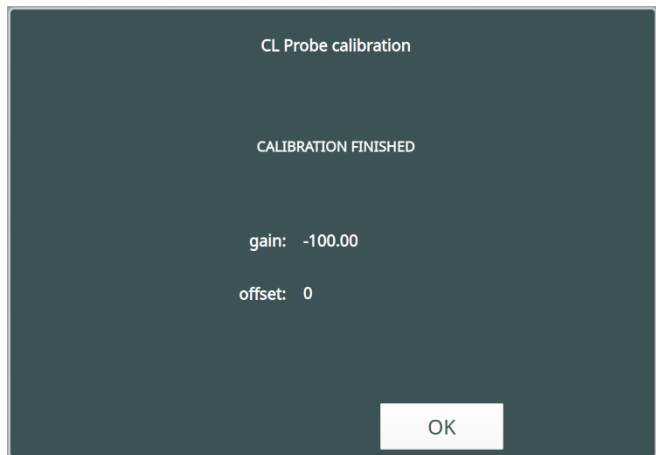

For CL_PM the gain value will be:

5. Press **OK** to return to the CL menu. The **“Last Calibration”** box will be updated to the current date.

4.5.3.5. TEMPERATURE

The screenshot shows the 'TEMPERATURE' settings page. At the top, there are navigation icons (home, list, settings, auto, hand, bell, help, power) and a unit selector 'F/°C Degrees' with a toggle for '°C'. A sidebar on the left lists menu items: SETTINGS, DEVICE, GENERAL, pH, RX, CL, AUX POWER, AUX PANEL, HEATING, mA, TEMPERATURE (highlighted), and CONFIG. The main area displays 'TEMPERATURE 15 °C' with up/down arrows and a 'CALIBRATE' button. Below this, it shows 'Last calibration 00/00/0000' and 'Temperature without cal 0.0 °C'. A 'SAVE' button is at the bottom right. Three callout boxes provide instructions: 1) 'Choose Centigrade degrees or Fahrenheit degrees.' points to the unit selector. 2) 'Real time temperature, measured in the water (same as home page)' points to the '15 °C' display. 3) 'Using ▲ ▼ it is possible to correct the temperature value by adding an offset. Press CALIBRATE, to save the temperature correction.' points to the arrows and the 'CALIBRATE' button. A fourth callout box, 'Information about the temperature detected by the probe in the water, without any correction.', points to the 'Temperature without cal' display.

NOTE:



Always press SAVE to make the modification effective.

4.5.3.6. AUXILIARY OUTPUTS CONFIGURABLE TYPES

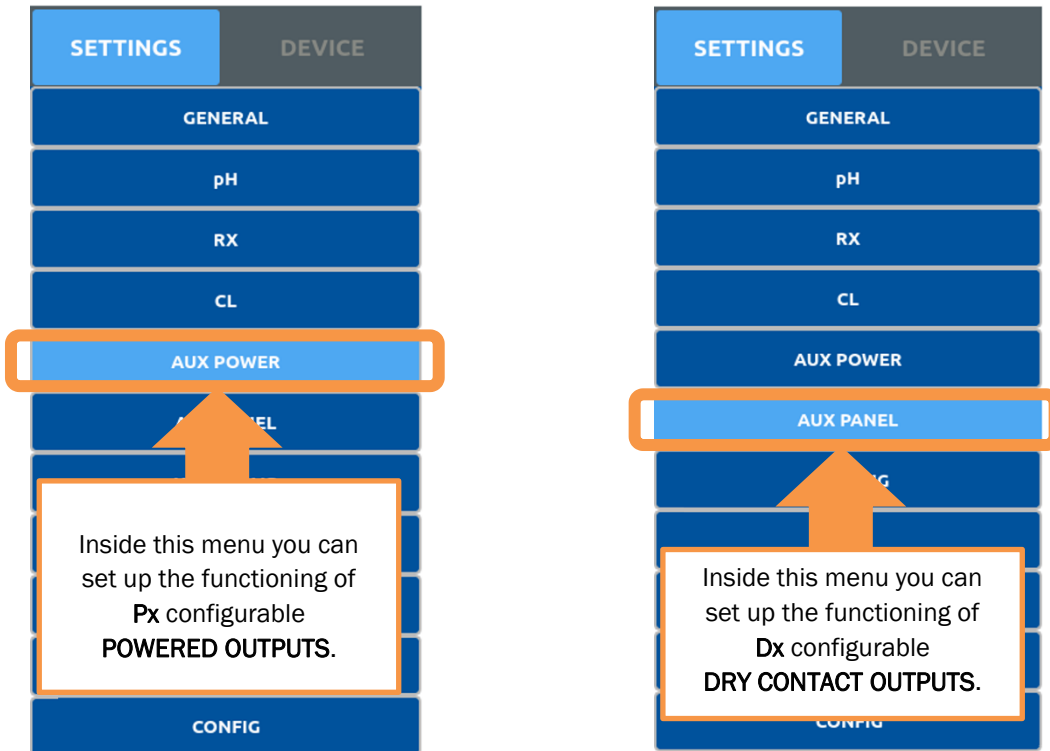

4.5.3.6.1. TIMER TYPE

Configure up to 3 daily timers to program the activation of the output.:

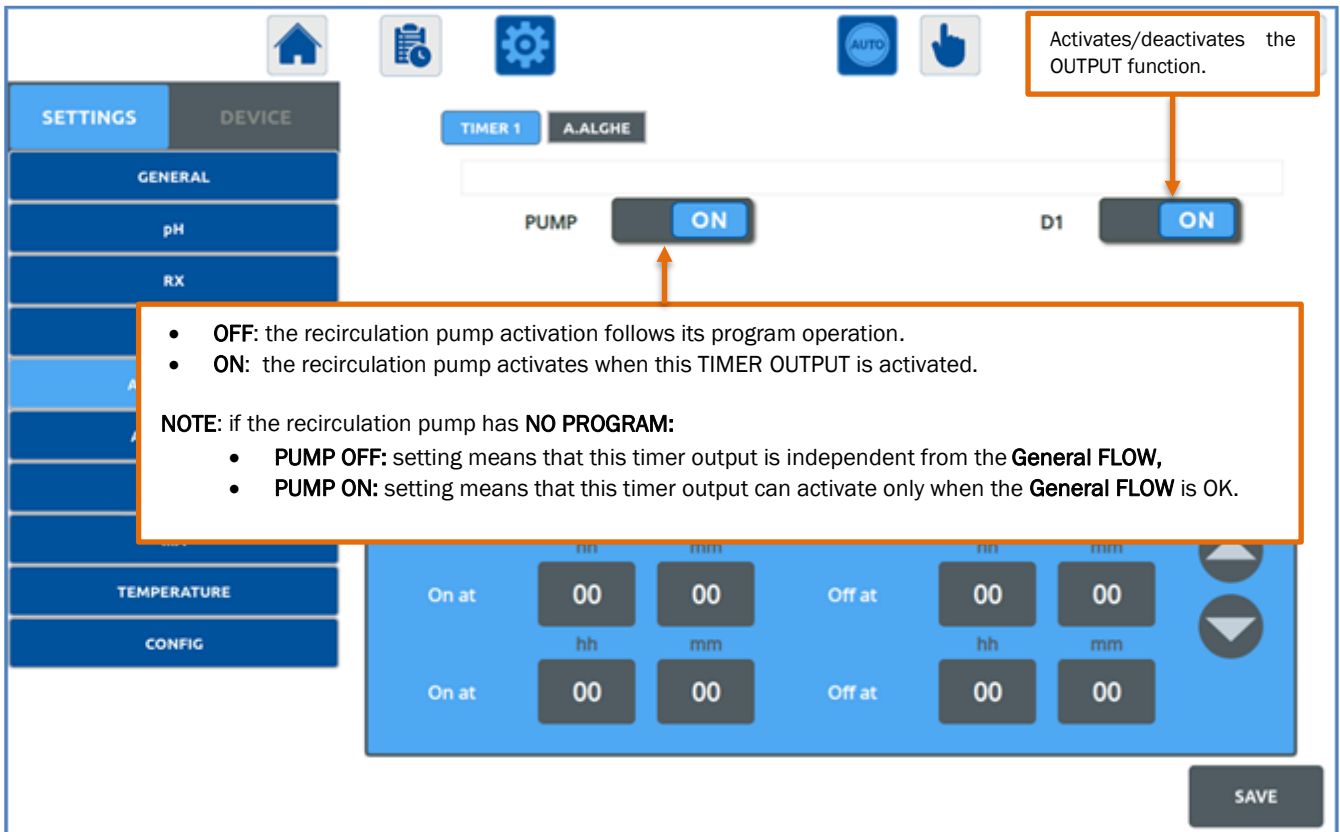

With a short press on the day, you access in the settings for the selected day.

With a second short press on the day, the timer you activate the timer on that day (blue colour).

With a short press on the box hh:mm you can modify the On/Off time (hours and minutes) using the ▲ ▼ arrows.

If you wish to use the daily program already set, copy it for the entire week by pressing SET ALL WEEK

NOTE:



1. Weekdays colour:
 - a. BLUE: the timer is active on the day.
 - b. GREY: the timer is not active on the day
2. Always press SAVE to make the modification effective.
3. Values of On at "00:00" and Off at "00:00" → no programming

4.5.3.6.2. MICRODOSE TYPE

A dosage is performed at the beginning of each hour of filtration.

The dosing time is automatically calculated based on the pool volume and the filtering hours of the day.

Activates/deactivates the OUTPUT function.

Pool volume in cubic meters.

FOLLOW PUMP PROGRAMS:

- ON: the chemical dosing follows the operating times of the PUMP PROGRAM selected in Programs.
- OFF: the chemical dosing follows the water flow detected by FLOW SENSOR.

If "Follow Pump Programs" is OFF, you need to set the Total Daily Filtering Period for every weekday.
With a short press on the day, you access in the settings for the selected day.
With a second short press on the day, the dosage is active on that day (blue colour).
Set the Total Filtration day Time value using the ▲ ▼ arrows.
If you wish to use the daily program already set, copy it for the entire week by pressing SET ALL WEEK

NOTE: when the "Follow Pump Program" is in OFF mode:



1. Weekdays colour:
 - a. BLUE: the dosage is active on the day.
 - b. GREY: the dosage is not active on the day.
2. Always press SAVE to make the modification effective.

4.5.3.6.3. REPEAT TYPE

This type of output repeats the functioning of the selected inputs or outputs (one or more).
The output is activated when an input or an output among the chosen ones is activated.
It is possible to activate this output when the device is performing a pH priority and a dosing delay.

NOTE:

1. Inside the "INCLUDE" section you can choose up to 4 INPUTS or OUTPUTS you wish to repeat.
 - Press the arrow ▼ to view the drop-down menu for the choice.
2. for the OUTPUT repetition it is recommended to include only one option.
3. Always press SAVE to make the modification effective.

Defines the output functioning:
Normally Open (N.O).
Normally Closed (N.C).

INPUT/OUTPUT activates the relative column for the choice.

Possible INPUT to repeat:

- - (not set)
- IN1
- IN2
- IN3
- IN4
- IN5
- HEAT
- PUMP
- FL
- PH
- PH PRIORITY
- DOSING DELAY

Possible OUTPUT to repeat:

- - (not set)
- PUMP
- P1
- P2
- P3
- P4
- D2
- LIGHTS
- PH
- HEAT

4.5.3.6.4. DRY AUXILIARY OUTPUTS

Inside this menu you can set up the functioning of Lights and D1/D2 configurable Dry Outputs.



IMPORTANT: DRY CONTACTS ARE FREE OF POTENTIAL (RELAYS) WITH A PROTECTION OF 5 AMPERES. DO NOT EXCEED THIS ELECTRICAL INTENSITY.

4.5.3.6.5. LIGHTS

Configure up to 3 daily timers to program the activation of lights.

Activates/deactivates the LIGHTS Output.

With a short press on the day, you access in the settings for the selected day.
With a second short press on the day, the timer you activate the timer on that day (blue colour).

With a short press on the box hh and mm you can modify the On/Off time (hour and minutes) using the ▲ ▼ arrows
If you wish to use the daily program already set, copy it for the entire week by pressing SET ALL WEEK

NOTE:



1. Weekdays colour:
 - a. BLUE: the timer is active on the day.
 - b. GREY: the timer is not active on the day.
2. Always press SAVE to make the modification effective.
3. Values of On at "00:00" and Off at "00:00" → no programming

4.5.3.6.6. HEATING FUNCTION

- 1) Program the daily activation of the HEATING program.
- 2) Enter the values of MIN and MAX temperature thresholds required to start up and shut down the heater. Once the temperature reaches the value of the maximum temperature, heater will shut down and, when it falls to the minimum, it will start up again.

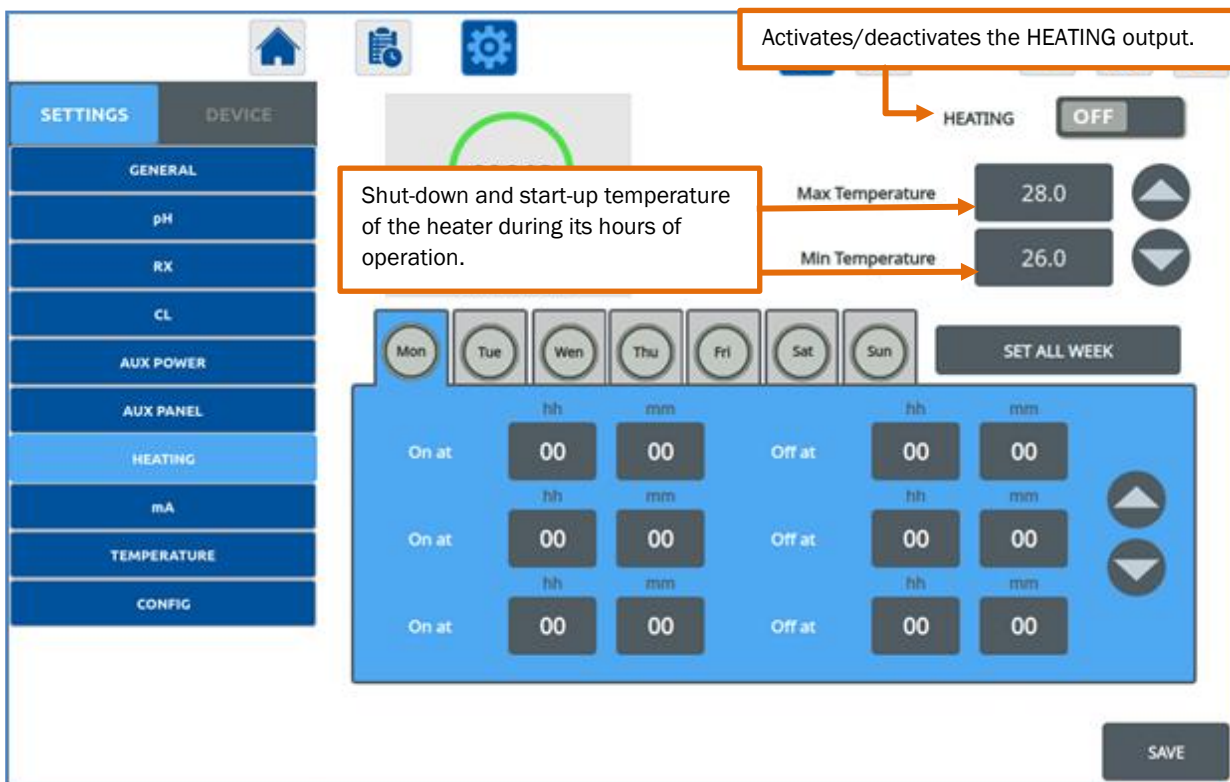

NOTE:



- To activate the heat control:
 - With a short press on the day, you access in the settings for the selected day.
 - With a second short press on the day, the heat control is activated on that day (blue colour).
 - Set the desired time values using the ▲ ▼ arrows.
 - If you wish to use the daily program already set, copy it for the entire week by pressing SET ALL WEEK.
- Weekdays colour:
 - a. BLUE: the heat control is active on the day.
 - b. GREY: the heat control is not active on the day.

- Always press SAVE to make the modification effective.
- Values of On at “00:00” and Off at “00:00” → no programming

4.5.3.7. mA OUTPUT (OPTIONAL)

It is possible (OPTIONAL) to add up to 2 milliamperes (mA) outputs to connect the Microdos Pooltec to regulation pumps that are controlled by 0/4 – 20mA standard:

By pressing the EXPERT button, this window will appear:

NOTE:



TO MODIFY THE PARAMETERS VALUE:

- Press on the button of the value you wish to modify and use the ▲ ▼ arrows.
- Press SAVE to make the modification effective.

4.5.3.8. CONFIG MENU

NOTE:



To configure these output types, please consult your Installer.

Inside this menu you can display the setup of the configurable Inputs and Outputs.

No changes are allowed to the user inside this Menu. Modifications are only allowed to the Installer (INSTALLER PASSWORD required)

The installer can change his password

It is possible to rename all the INPUTS and the OUTPUTS

Defines if the INPUT functioning is:
Normally Open (N.O).
Normally Closed (N.C).

OUTPUTS		INPUTS	
	NAME	TYPE	
P1	Rx	RX	IN1 Rx LEVEL AL. P1 N.O
P2	Cl	CL	IN2 Cl LEVEL AL. P2 N.O
P3	TIMER 1	TIMER	IN3 Cl FLOW GENERAL N.O
P4	A.ALGAE	MICRODOSE	IN4 A.ALGAE LEV. AL. P4 N.O
D1	AUX1	TIMER	IN5 COVER ALERT N.O
D2	AUX2	TIMER	

It is possible to define the OUTPUT TYPE to choose between:

- TIMER
- REPEAT
- pH
- Rx
- CL
- TEMP
- MICRODOSE

Define the INPUT TYPE, to choose between:

- NOT SET
- AL.P1
- AL.P2
- AL.P3
- AL.P4
- AL.D1
- AL.D2
- ALERT
- GENERAL

4.5.4. DEVICE SETTINGS

4.5.4.1. SET THE SLEEP TIMER OF THE SCREEN

The unit has an automatic screen stop system as a function of time that you can program. The screen will then turn off, but the unit will continue to operate normally. To turn it back on, simply touch the screen.

If you put 00:00 it will never go out.

NOTE:

Always press **SAVE** to make the modification effective.

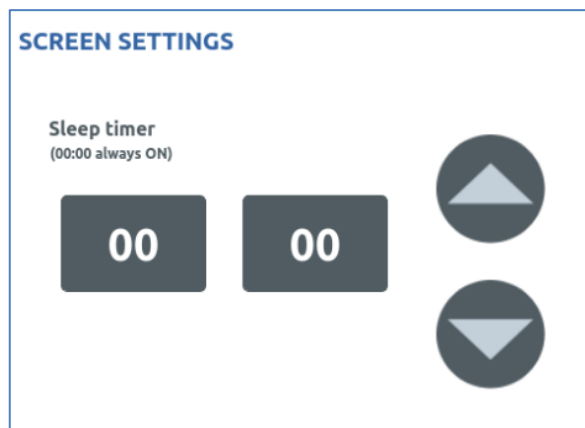

4.5.4.2. CONNECTION WIFI OR ETHERNET

It is advisable to have access to Internet service, to update the software and to manipulate, maintain and have full information on your system through your computer or mobile phones (Android and iOS apps are available). To do this you can use an Ethernet connection or a WIFI connection. Follow next steps:

ETHERNET CABLE CONNECTION

- connect the LAN cable
- Turn on Ethernet

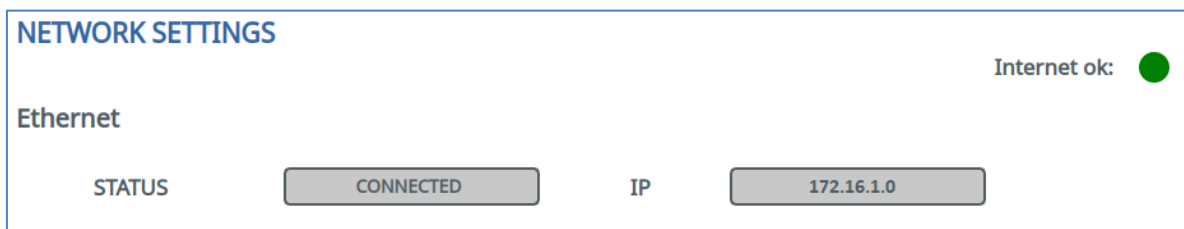

WHEN THE DEVICE DETECTS THE CONNECTION AND CONNECTS TO INTERNET, THE STATE AND THE IP WILL APPEAR. Also, the "Internet ok" dot will turn from **RED** to **GREEN**.

If it does not connect, the message "NOT CONNECTED" will appear on the STATUS and the "Internet ok" dot will stay **RED**.

Wi-Fi CONNECTION

To establish the internet connection via Wi-Fi:

1. Turn on the Wi-Fi
2. Press the "FIND SSID" button
A list of Wi-Fi networks available for connection will appear in the side box.
3. Select the desired Wi-Fi network from the list
4. Enter the password (if requested)
5. Press CONNECT

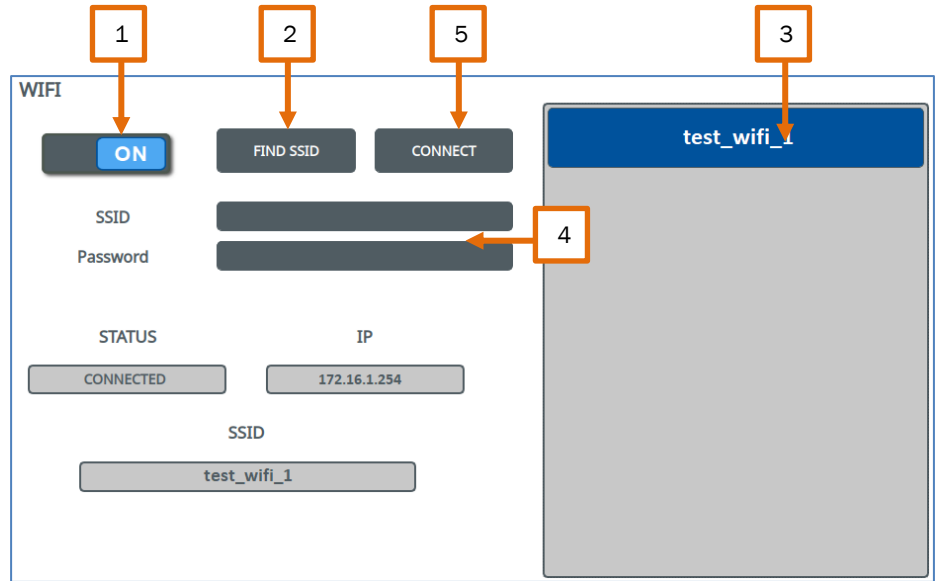

Once connected to the network via Wi-Fi, STATUS displays the status of the connection, IP the address and SSID the name of the network to which you are connected.

4.5.4.3. DATE AND TIME

To configure the date/time you can choose between two possible options:

- **AUTO:** If the system is connected to internet, you can choose the AUTO MODE. Press the AUTO button and set the time zone. The system will automatically set the date and time accordingly. Press **SAVE** to make the modification effective.

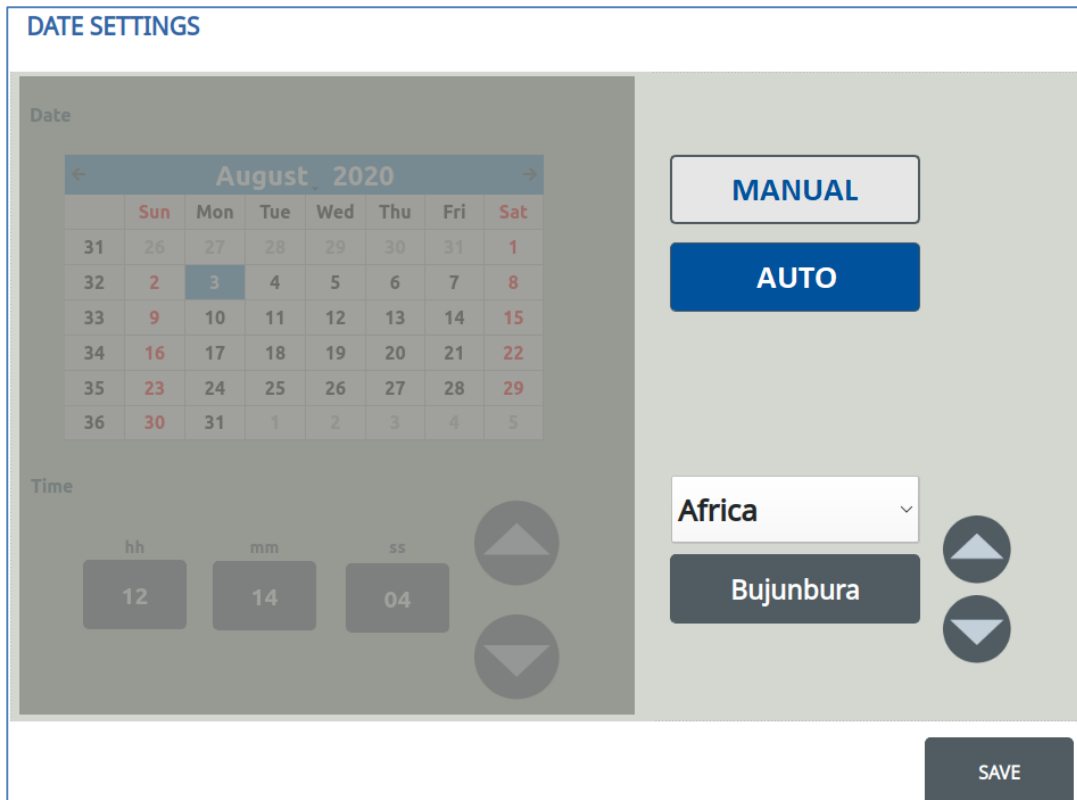

- **MANUAL:**
If the system is not connected to the internet, you can choose the MANUAL MODE.
Press the MANUAL button.
First of all set the time zone and then set date and time manually. **Press SAVE to make the modification effective.**

DATE SETTINGS

Date

	Sun	Mon	Tue	Wed	Thu	Fri	Sat
31	26	27	28	29	30	31	1
32	2	3	4	5	6	7	8
33	9	10	11	12	13	14	15
34	16	17	18	19	20	21	22
35	23	24	25	26	27	28	29
36	30	31	1	2	3	4	5

Time

hh: 00 mm: 00 ss: 00

Africa

Bujunbura

SAVE

4.5.4.4. CHANGING THE LANGUAGE

To change the system language, select a language and **press SAVE**.

LANGUAGE SETTINGS

Language

English

Save

Available languages:

- English
- French
- Italian
- Spanish
- Dutch
- German
- Russian

4.5.4.5. ACTIVATE/DEACTIVATE REMOTE CONTROL

To activate/deactivate remote control and enable remote/Internet system access, you need to set this option to ON.

REMOTE CONTROL SETTINGS

Remote control

OFF

When ON, this option enables the connection to the Server:

<https://www.pooltec-pro.com/>

Press **SAVE** to make the modification effective.

4.5.4.6. UPDATE SOFTWARE (DOWNLOAD)

Download and install system updates.
For the correct installation of the software:

- Choose if you want to **DOWNLOAD** the update from USB or from the pooltec-pro.com server.
- The corresponding **UPDATE** button will appear.
- Press **UPDATE**.

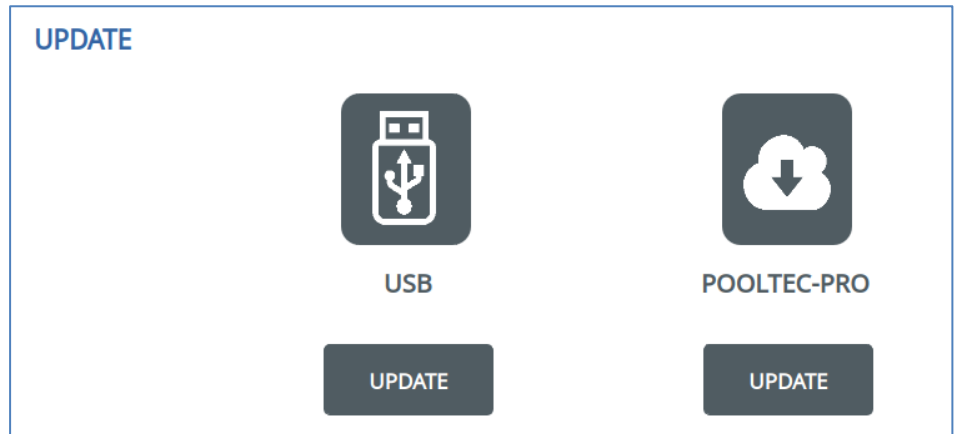

The system will reboot with the updated version of the software.

4.5.4.7. DEVICE INFO: SYSTEM MODEL AND SERIAL NUMBER: SOFTWARE VERSION

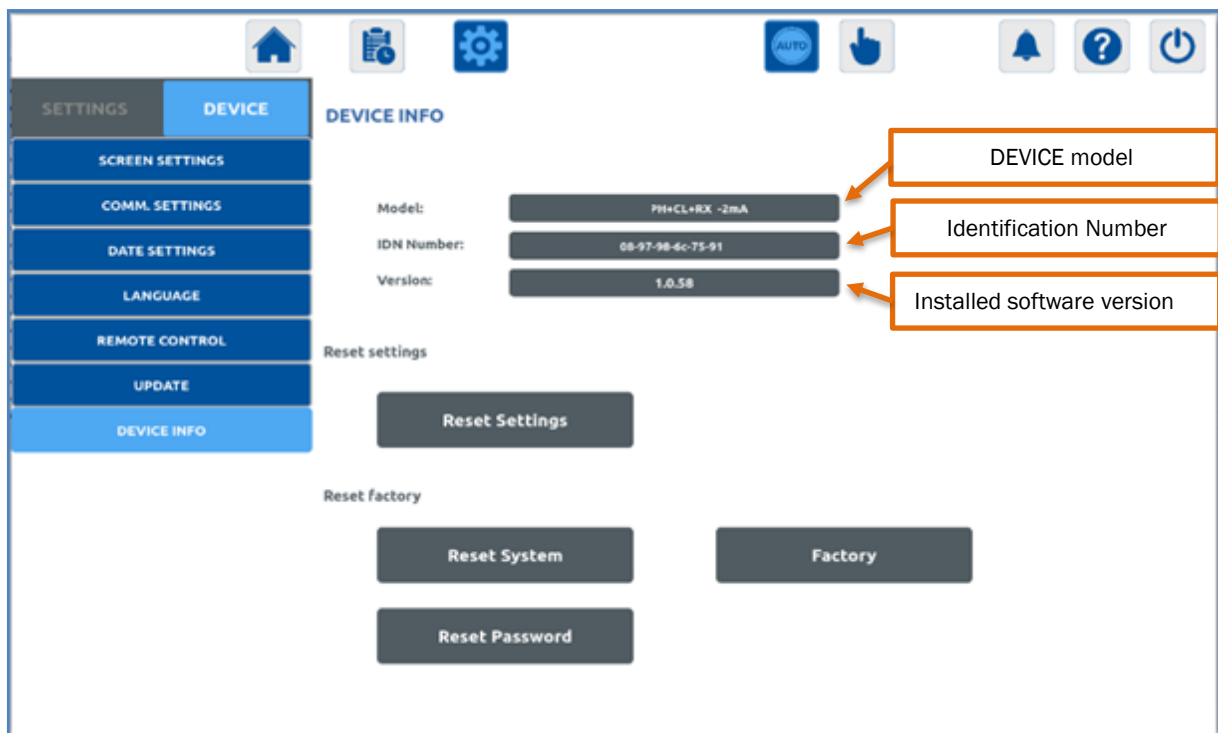

Inside this page is also possible to perform 3 different Resets:

RESET SETTINGS: press to reset all parameters to default values (see page 50). Probe calibrations, all modification done in CONFIG page and measurement history will not be erased.

RESET SYSTEM: press to reset the system to the initial factory configuration (Probe calibration and all modification done in CONFIG page will be erased, measurement history will not be erased).

PASSWORD RESET: press to reset the installer password to the factory value. To do this you will need a *Passepartout*: please contact the customer care service.



AFTER A RESET, THE SYSTEM WILL REBOOT

There is also the **FACTORY** configuration, only accessible from the manufacturer.

4.5.4.8. MEASUREMENT HISTORY

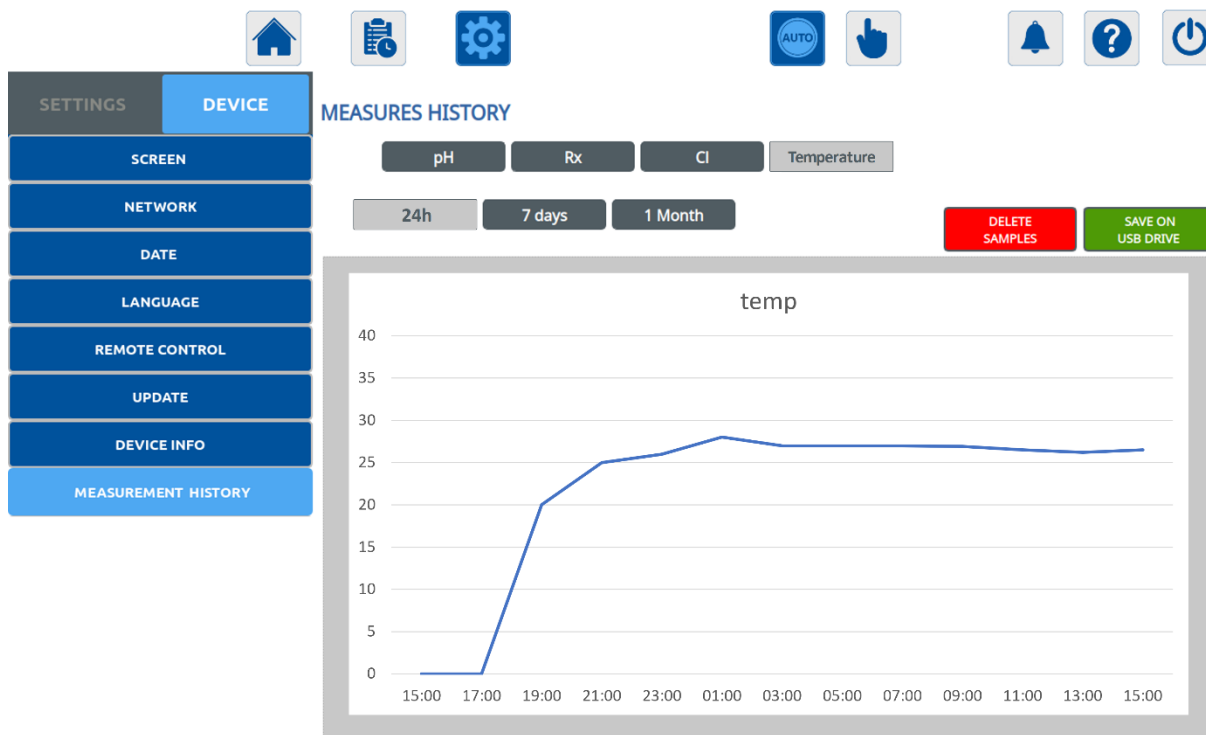

History of measurements recorded every 30 minutes

It is possible to display PH, REDOX, CHLORINE, TEMPERATURE measurement value graphics of:

- **The day.**
- **The week.**
- **The month.**

It is strongly necessary to delete samples at least every 6 months.
Take care to save before in a usb pen drive.

If you connect a **USB DRIVE** in the system, it is also possible to download the recorded measurement values in CSV file format.

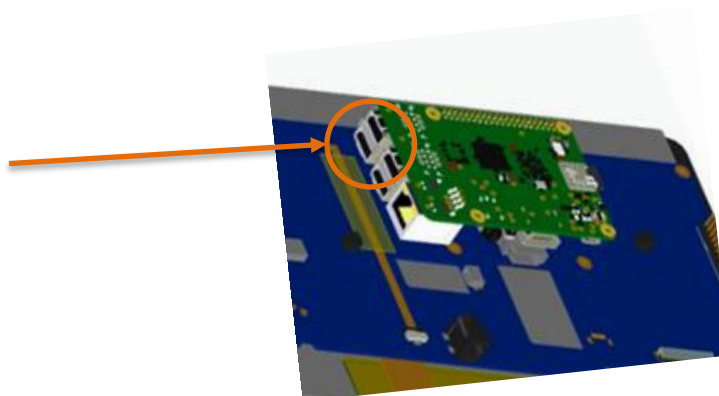

NOTE:



AFTER ANY CHANGE INSIDE THE "DATE MENU", ALWAYS DELETE THE RECORDED SAMPLES WITH THE "DELETE SAMPLES" RED BUTTON.

5. POOLTEC PRO

5.1. Registration

To control the device remotely, register it on www.pooltec-pro.com

5.1.1. NEW USER REGISTRATION

Click on **Register as costumer**

Fill in all the fields (username, password, e-mail) and then click on **Register**

New Customer Registration

	Username *
	Password *
	Confirm Password *
	E-Mail *
	Confirm E-mail *

* Fields Required

Register

Step 1 Completed

Dear customer,
A code has been sent to your e-mail address. Please follow the instructions in the e-mail to continue the registration process.
If you have not received an e-mail, please check your spam folder.

Wait for the confirmation email sent by postmaster@pooltec-pro.com (check the SPAM folder).

MICRODOS - VERIFICATION CODE

Microdos <postmaster@pooltec-pro.com>

Dear,

Welcome in Microdos.

Please click on the following link in order to continue with the registration.

www.pooltec-pro.com//home_activation.php?registrationCode=

To continue registration click on the link.

Fill in all the fields (name, address, etc.), accept the terms and then click on **Register**.

Customer Registration - Final Step

*

*

*

*

*

The field below is a not-mandatory field. If filled in, you accept the terms of use.

* Fields Required

I accept [terms of use and privacy policy](#).

Register

5.1.2. NEW DEVICE REGISTRATION

Do the Login by entering your username and password.
Click on **DEVICES** and then on **ADD NEW DEVICE**.
Fill in all fields:

idn: enter the alphanumeric code reported in **DEVICE INFO** (see page 44).

Alias: choose a name to assign to the device.

Serial: enter the numeric code S/N shown on the label.

Alarm Mail: necessary to receive notifications in real time about any alarms in progress

Subsequent data is required only for the purpose of geolocation, to allow the installer to locate the device more quickly.

Welcome.

Home
Devices
Account
Manual
FAQ
Contact
Terms & Privacy
Logout

Discover t

DEVICE

Please insert your new device's data

Next information allows emails alarms and device geolocation

Cancel
OK

ADD NEW DEVICE

Company: Microdos Srl
 VAT Number: 00959430574
 Address: Via Maestri del Lavoro, 5 - 02100 Rieti
 Email: info@microdos.it
 Telephone: +39 0746 229984

5.2. App

5.2.1. ANDROID APP

Download the app from the Google Play

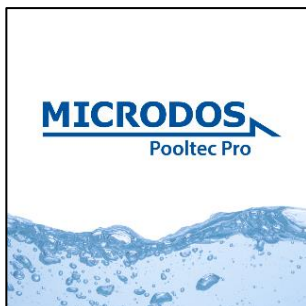

https://play.google.com/store/apps/details?id=com.hustay.swing_d6b234b5ea2814363a9b6bd4a236d74d8&gl=IT

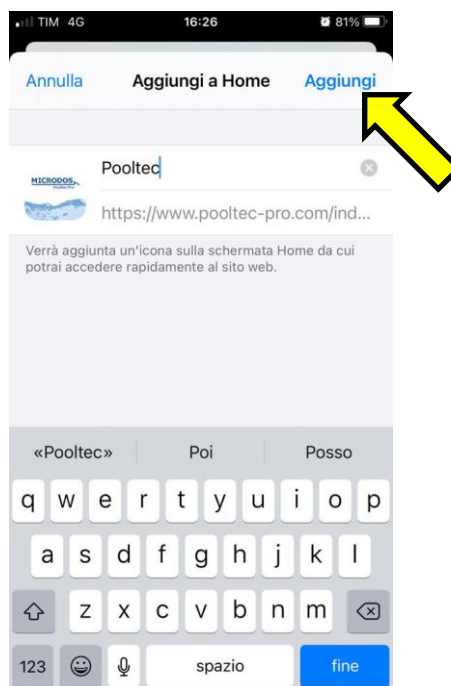
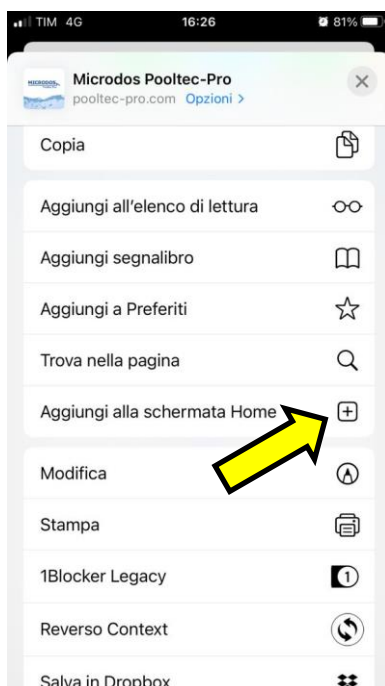
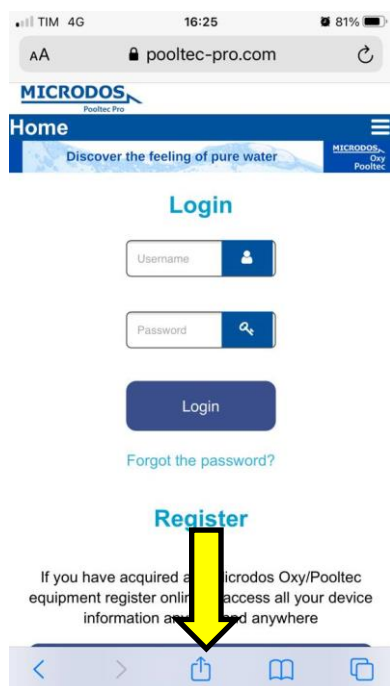

5.2.2. IOS APP

To install the App on your iPhone:



- 1) Open Safari
- 2) Go to www.pooltec-pro.com
- 3) Touch 
- 4) Select "Add to Home" 
- 5) Press "Add"



6. STARTING UP

6.1. DEFAULT CONFIGURATION

FUNCTIONING MODE

AUTO/MANUAL	AUTO
-------------	------

PROGRAM SET

AUTOTEMP		OFF
USER PROGRAM		OFF
PUBLIC POOL		OFF
WINTER		OFF
NO PROGRAM		ON

GENERAL SETTINGS:

REPORT	ON
GENERAL FLOW ALARM	OFF
PH PRIORITY	OFF
DECALCIFICATION	OFF
RX DEPENDENCE	OFF
DOSING PUMPS DELAY	00:00

MEASUREMENTS SETTINGS:

MEASURE	PH	RX	CL
BASIC			
HOME	ON	ON	ON
REGULATION PUMP	OFF	OFF	OFF
0%	7.20PH	730mV	1.30ppm
100%	8.20PH	630mV	0.30ppm
EXPERT			
LOW	6.80PH	250mV	0.30ppm
HIGH	8.40PH	900mV	2.00ppm
OVERDOSE	00:00	00:00	00:00
OVERDOSE LIMITS	00:00	00:00	00:00

TIMER (VALID FOR ALL TYPES):

WEEKDAYS	NO DAYS
ON AT	00:00
OFF AT	00:00

TIMER TYPE:

PUMP	OFF
Px	OFF

MICRODOSE TYPE:

VOLUME MC	0
FOLLOW PUMP PROGRAM	Off
TOTAL DAILY FILTRATION	00:00
Px	OFF

LIGHTS:

LIGHTS	OFF
--------	-----

REPEAT TYPE:

Px	N.O
INPUT/OUTPUT	INPUT
INCLUDE	-

HEAT PUMP:

HEAT PUMP	OFF
MIN TEMPERATURE	26°C
MAX TEMPERATURE	28°C

mA OUTPUTS:

OUTPUT	mA1		mA2	
MODEL CONFIGURATION	pH	pH-RX	pH-CL	pH-RX-CL
BASIC				
MEASURE	PH	RX	CL	CL
4mA	7.20PH	730mV	1.30ppm	1.30ppm
20mA	8.20PH	630mV	0.30ppm	0.30ppm
EXPERT				
AL.mA	0.00mA	0.00mA	0.00mA	0.00mA
OVERDOSE	00:00	00:00	00:00	00:00
OVERDOSE LIMITS	00:00	00:00	00:00	00:00

TEMPERATURE:

°C/°F	°C
-------	----

6.2. RECOMMENDED TIME SCHEDULE FOR PRIVATE/PUBLIC POOLS

For the Pooltec system to be efficient, we need to remember that the hours of daily operation depend directly on the water temperature. The higher the temperature, the greater the number of hours of operation required.

For this, we recommend:

Private pools: we recommend the AUTO-TEMP program.

Public pools: we recommend the PUBLIC POOL program (24 hours continuously)

7. MAINTENANCE OF THE MICRODOS POOLTEC

7.1. MAINTENANCE AND CONTROL PANEL

From now on, the only thing we need to do is to maintain the system, checking the parameters detailed below:

GENERAL MAINTENANCE

- Replenish/ replace the tanks for products used. You must never allow these to get low.
- Change the measurement probes for pH and Rx as soon as the calibration frequency increases, or they fail to calibrate (Approximately 2 years under normal conditions of use). Never allow a probe to have no water.
- It is strongly necessary to delete samples of measurements at least every 6 months (DEVICE→HISTORY MEASUREMENTS→DELETE SAMPLES)

DAILY MAINTENANCE

- Ensure that the pump is working, and that no alarms have been triggered (visually in orange).
- Ensure that the water is clean and clear (visually).

MONTHLY MAINTENANCE

- Check the pH in the vessel at least once a month (using colour-graded or digital gauges).

BI-MONTHLY MAINTENANCE

- Calibrate the pH and Rx probes, or whenever the vessel measurement does not agree with what is indicated on the control unit by ± 0.2 pH.
- Check the silicon injection pipe, product pipes and injectors of the dosing pump(s).

7.2. BATTERY REPLACEMENT

The device has a buffer battery inside to keep the date and time in memory when it is not powered. To replace the battery it is necessary to open the cover and access the internal compartment.

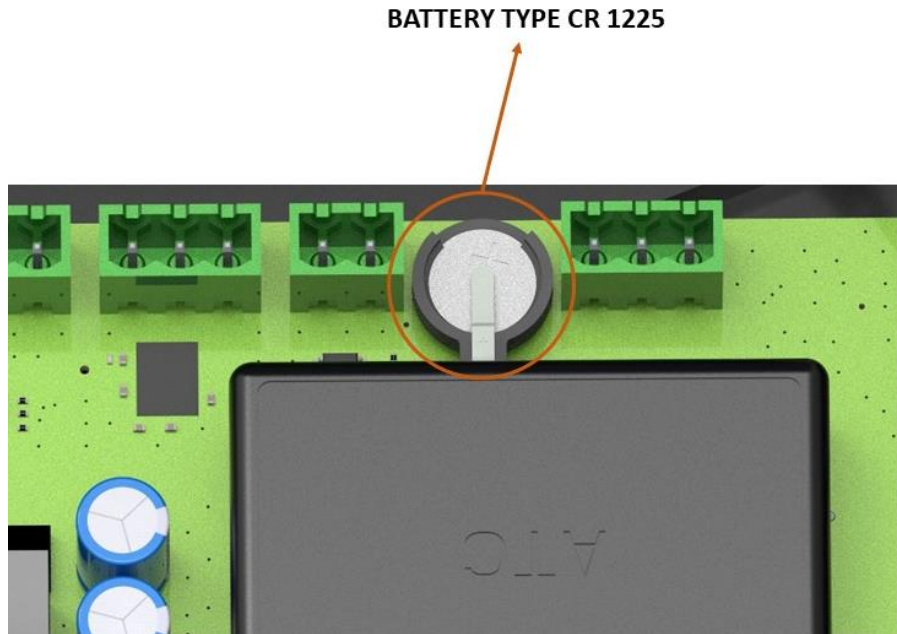

8. INCOMPATIBILITIES

Microdos POOLTEC is fully compatible with any other treatment apart from chlorine, bromine, active oxygen, etc...



Via Maestri del Lavoro, 5 - 02100 - Rieti - Italy
Tel: +39/0746/229064 Fax: +39/0746/221224 www.microdos.it