



FAIRLAND®

TurboSilence Inverter



SUMMARY

For users P.3-P.10

1. GENERAL INFORMATION	3
1.1. Contents:	3
1.2. Operating conditions and range:	3
1.3. Advantages of different modes:	3
1.4. Kind reminder:	4
2. OPERATIONS	6
2.1. Notice before using	6
2.2. Operation instructions	6
2.3. Daily maintenance and winterizing	9
3. TECHNICAL SPECIFICATION	10

For installers and professionals P.11-P.27

1. TRANSPORTATION	11
2. INSTALLATION AND MAINTENANCE	11
2.1. Notice before installation:	11
2.2. Installation instruction	12
2.3. Trial after installation	15
2.4. Maintenance and winterizing	16
3. TROUBLE SHOOTING FOR COMMON FAULTS	16
4. FAILURE CODE	17
APPENDIX 1: HEATING PRIORITY WIRING DIAGRAM (OPTIONAL)	18
APPENDIX 2: HEATING PRIORITY WIRING DIAGRAM (OPTIONAL)	19
APPENDIX 3: HEATING PRIORITY WIRING DIAGRAM (OPTIONAL)	20
5. WIFI SETTING	22

PLEASE READ IT CAREFULLY AND KEEP IT FOR SUBSEQUENT USE

This manual provides you necessary information for optimal use and maintenance



Warning:

- a. Please read the following tips before installation, use and maintenance.
- b. Installation, removal and maintenance must be carried out by Professional personnel in accordance with the instructions.
- c. Gas leakage test must be done before and after installation.

1. Use

- a. It must be installed or removed by professionals, and it is forbidden to dismantle and refit without permission.
- b. **Don't put obstacles before the air inlet and outlet of the heat pump.**

2. Installation

- a. This product must be kept away from any source of fire.

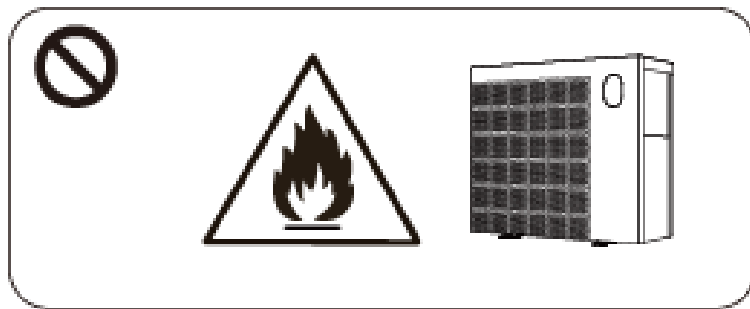

- b. The installation can't be in a closed environment or indoors, and must be kept well ventilated.

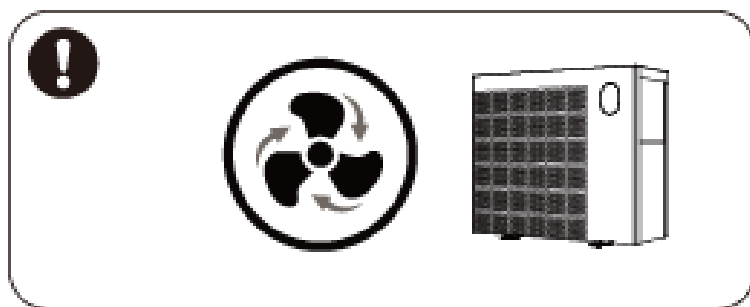

- c. Vacuum completely before welding, field welding is not allowed, welding can only be performed by professional personnel in professional maintenance center.

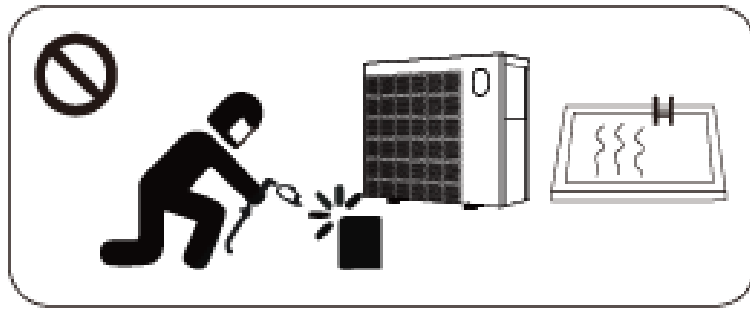

- d. Installation must be stopped if any gas leakage, and the unit must be returned to professional maintenance center.

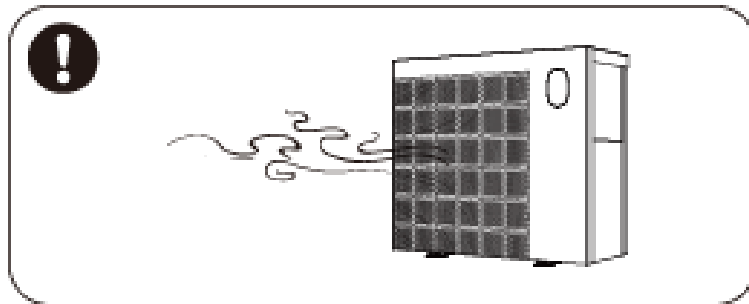

3. Transportation & Storage

- a. Sealing is not allowed during transportation
- b. Transporting goods at a constant speed is needed to avoid sudden acceleration or sudden braking, so as to reduce the collision of goods.
- c. The unit must be far away from any source of fire.
- d. Storage place must be bright, wide, open and good ventilation, ventilation equipment is required.

4. Maintenance Notice

- a. If maintenance or scrap is required, contact an authorized service center nearby
- b. Qualification requirement
All operators who dispose gas must be qualified by valid certification which issued by professional agency.
- c. Please strictly comply with the requirement from manufacturer when maintenance or filling gas. Please refer to the technical service manual.

1. GENERAL INFORMATION

1.1. Contents:

After unpacking, please check if you have all the following components.

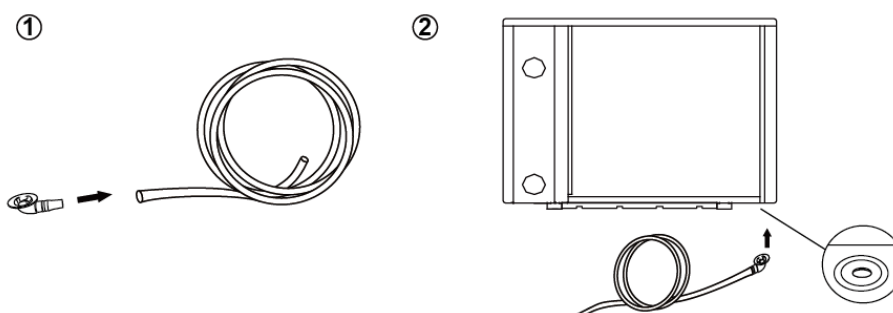
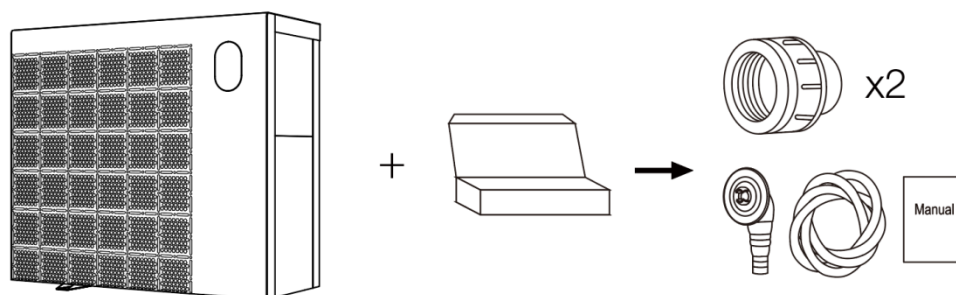



1.2. Operating conditions and range:

ITEMS		RANGE
Operating range	Air temp	-15°C~43°C
Temp. setting	heating	18°C~40°C
	Cooling	12°C~30°C

The heat pump will have ideal performance in the operation range Air 15°C~25°C.

1.3. Advantages of different modes:

The heat pump has three modes: Turbo, Smart and Silence. They have different advantages under different conditions.

MODE	ADVANTAGES
Turbo mode 	Heating capacity: 120% Fast heating
Smart mode 	Heating capacity: 100%~20% Intelligent optimization according to ambient temperature and water temperature Energy efficiently saving
Silence mode 	Heating capacity: 60%~20% Use at night

1.4. Kind reminder:

 This heat pump has Power-off memory function. When the power is recovered, the heat pump will restart automatically.

- 1.4.1. The heat pump can only be used to heat the pool water. **It can NEVER** be used to heat other flammable or turbid liquid.
- 1.4.2. Don't lift the water union when moving the heat pump since the titanium heat exchanger inside the heat pump will be damaged.

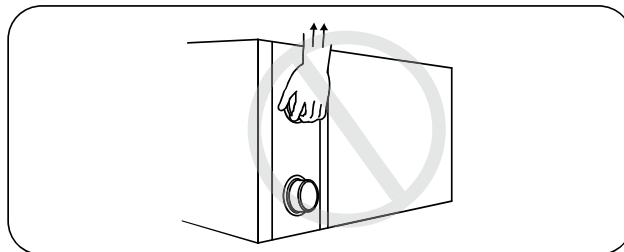

1.4.3. Don't put obstacles before the air inlet and outlet of the heat pump.

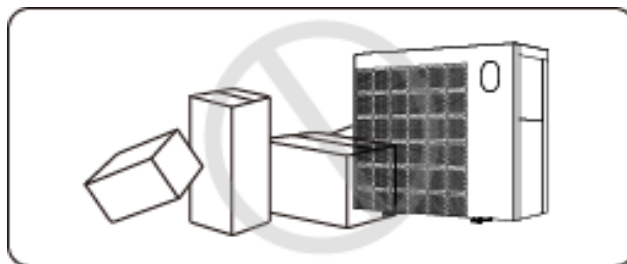

1.4.4. Don't put anything into inlet or outlet, or the efficiency of the heat pump will be reduced or even stopped.

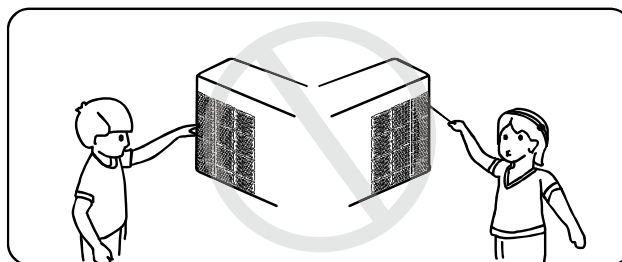

1.4.5. Don't use or store combustible gas or liquid such as thinners, paint and fuel to avoid fire.



1.4.6. If any abnormal circumstances occurred, **e.g.: abnormal noises, smells, smokes and leakage of electricity, switch off the main power immediately and contact your local dealer.** Don't try to repair the heat pump by yourselves.

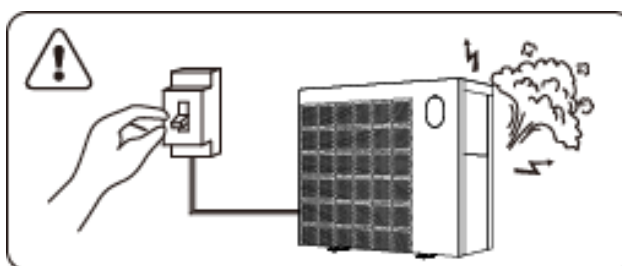



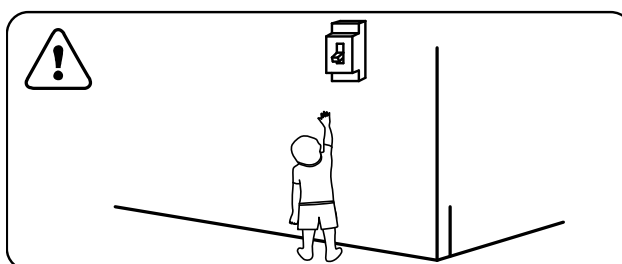

1.4.7. The main power switch should be out of the reach of Children.

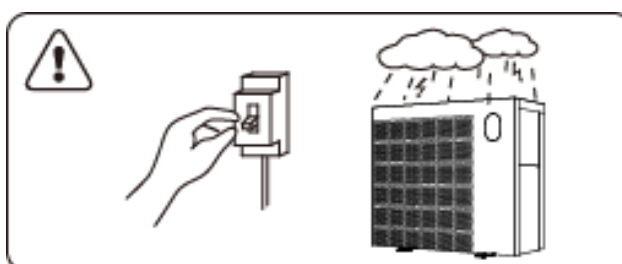

1.4.8. Please cut off the power in the lightning storm weather.



1.4.9. Please note that following codes are not failure.

	CODES
No water flow	
Anti-Freezing Reminder	
Out of the operating range	
Insufficient water flow or pump blocked	
Power abnormal	

2. OPERATIONS





2.1. Notice before using

2.1.1. For longer service life, please ensure water pump is on before heat pump starts to work, and water pump is off after heat pump is off.

2.1.2. Ensure no water leakage on piping system, then unlock screen and press  to power on heat pump.

2.2. Operation instructions



SYMBOL	DESIGNATION	FUNCTION
	ON/OFF	1. Power On/Off 2. Wifi setting
	Unlock	1. Press it for 3 seconds to unlock/lock screen 2. After screen is unlocked, press it to select mode. Auto (12~40°C) Heating (18~40°C) Cooling (12~30°C)
	Speed	Select Turbo/Smart/Silence mode
	Up / Down	Adjust set temperature

Note: (Button  will be light all the time when power is on.):

① Screen lock:







- a. If no operation in 30 seconds, screen will be locked.
- b. When HP is off, screen will be dark and "0%" will be displayed.

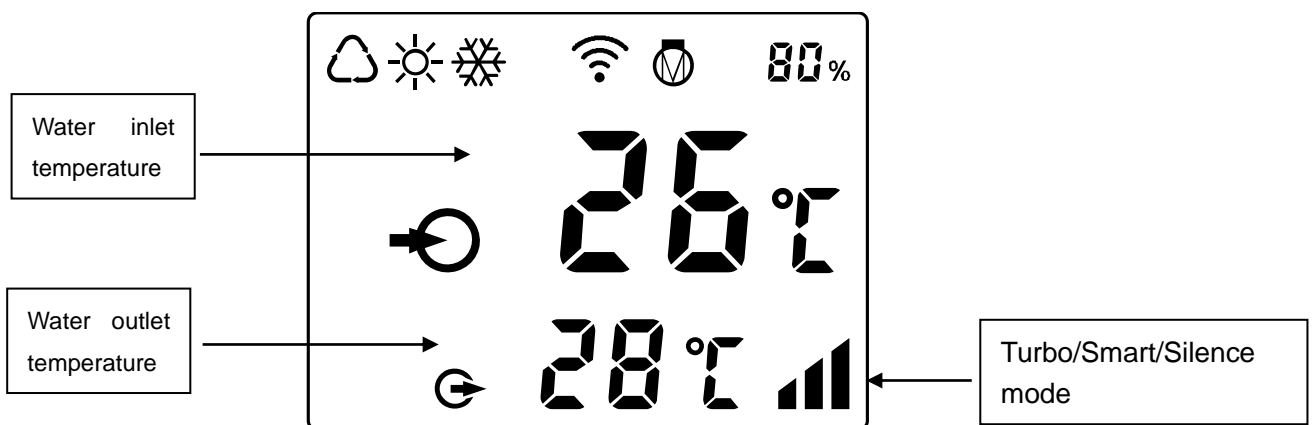

c. Press  for 3 seconds to lock screen and it will be dark

② Screen unlock:

- a. Press  for 3 seconds to unlock screen and it will be lit up.
- b. Only after screen is unlocked, any other buttons can be functioned.



	Heating
	Cooling
	Auto
	Heating capacity percentage
	Wifi connection
	Water inlet
	Water outlet

1. Power On: Press  for 3 seconds to light up screen, then press  to power on heat pump.

2. Adjust Set Temperature: When screen is unlocked, press  or  to display or adjust the set temperature.

3. Mode Selection: Press  to select mode.







Auto : adjustable temperature range 12~40°C

Heating : adjustable temperature range 18~40°C

Cooling : adjustable temperature range 12~30°C

4. Turbo/Smart/Silence mode selection:

① Smart mode as default will be activated when heat pump is on, and screen shows .

② Press  to enter Turbo mode, and screen shows , then press  to enter Silence mode, the screen shows . Press  again, the screen shows  and return to Smart mode.





Attention:

a. When use the Turbo mode, you should select it every time, the machine will not automatically enter the Turbo mode.

b. During the Turbo mode, when the machine reaches the set temperature, it will automatically return to the smart mode.

5. Defrosting

a. Auto Defrosting: When heat pump is defrosting,  will be flashing. After defrosting,  will stop flashing.

b. Compulsory Defrosting: When heat pump is heating, press  and  together for 5 seconds to start compulsory defrosting, and  will be flashing. After defrosting,  will stop flashing.

FOR USER

(Note: Compulsory defrosting intervals should be more than 30 minutes and the compressor should run for more than 10 minutes.)

6. Temperature display conversion between °C and °F:

Press " ^ " and " v " together for 5 seconds to switch between °C and °F.

7. Wifi setting

Please kindly check the last page.

2.3. Daily maintenance and winterizing

2.3.1. Daily Maintenance

Please don't forget to cut off power supply of the heat pump

- Please clean the evaporator with household detergents or clean water, NEVER use gasoline, thinners or any similar fuel.
- Check bolts, cables and connections regularly.

2.3.2. Winterizing

In winter season when you don't swim, please cut off power supply and drain water out of the heat pump. When using the heat pump under 2°C, make sure there is always water flow.

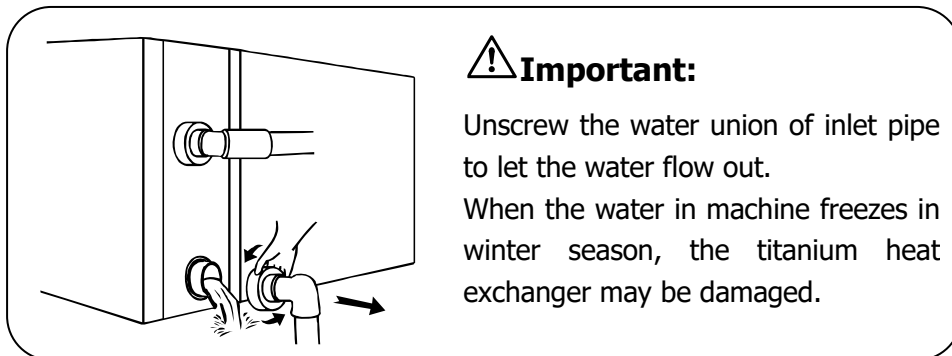

3. TECHNICAL SPECIFICATION

Model	IXCR26	IXCR36	IXCR46	IXCR56	IXCR66	IXCR80	IXCR80T	IXCR110T
Advised pool volume (m³)	20~40	25~50	30~60	40~75	55~100	65~120	65~120	90~160
Working air temp (°C)	-15~43							
Performance Condition: Air 26°C, Water 26°C, Humidity 80%								
Heating capacity (kW) in Smart mode	8.8	11.3	14.0	18.0	22.0	27.5	27.5	35.0
Heating capacity (kW) in Turbo mode	10.5	13.5	17.0	21.5	26.0	32.0	32.0	40.0
C.O.P in Smart mode	8.0	8.5	7.7	7.5	8.0	7.6	7.6	7.5
C.O.P	15.6~7.3	15.5~7.5	16.0~6.6	15.5~6.5	16.5~7.0	16.3~6.5	16.3~6.5	16.3~6.6
C.O.P at 50% speed	11.8	12.0	11.5	11.5	11.6	11.5	11.5	11.4
Performance Condition: Air 15°C, Water 26°C, Humidity 70%								
Heating capacity (kW) in Smart mode	6.3	7.5	9.5	12.0	15.0	18.5	18.5	24.5
Heating capacity (kW) in Turbo mode	7.5	9.0	11.5	14.5	18.0	22.0	22.0	28.5
C.O.P in Smart mode	5.4	5.5	5.2	5.2	5.6	5.5	5.5	5.3
C.O.P	7.1~4.9	7.0~5.0	7.5~4.5	8.0~4.7	8.0~5.1	8.0~5.0	8.0~5.0	8.1~4.8
C.O.P at 50% speed	6.7	6.7	6.8	7.0	7.0	7.0	7.0	6.9
Performance Condition: Air 35°C, Water 28°C, Humidity 80%								
Cooling capacity (kW)	4.5	5.8	6.7	8.2	12.0	14.0	14.0	16.5
Sound pressure at 1m dB(A)	38.5~45.5	38.6~46.9	42.0~47.7	42.9~50.8	40.8~51.2	43.3~51.9	43.3~51.9	42.5~51.7
Sound pressure of 50% capacity at 1m dB(A)	39.5	41.3	43.7	44.5	44.4	46.4	46.4	43.8
Sound pressure at 10m dB(A)	18.5~25.5	18.6~26.9	22.0~27.7	22.9~30.8	20.8~31.2	23.3~31.9	23.3~31.9	22.5~31.7
Power supply	230V/1 Ph/50Hz						400V/3 Ph/50Hz	
Rated input power(kW) at air 15°C	0.18~1.53	0.22~1.8	0.26~2.56	0.31~3.08	0.38~3.53	0.46~4.4	0.46~4.4	0.60~5.94
Rated input current(A) at air 15°C	0.78~6.65	0.96~7.82	1.14~11.3	1.35~13.4	1.65~15.3	2.01~19.1	0.66~6.35	0.87~8.57
Advised water flux (m ³ /h)	2~4	3~4	4~6	6.5~8.5	8~10	10~12	10~12	12~18
Water pipe in-out Spec (mm)	50							
Net Dimension Lx WxH (mm)	799×432× 650	893×432× 650	939×432× 650	995×432× 750	1125×429× 952	1074×539× 947	1074×539× 947	1260×539× 947
Net Weight (kg)	51	61	65	70	98	102	111	126

- The values indicated are valid under ideal conditions: Pool covered with an isothermal cover, filtration system running at least 15 hours a day.
- Related parameters subject to adjustment periodically for technical improvement without further notice. For details please refer to nameplate.

1. TRANSPORTATION

1.1. When storing or moving the heat pump, the heat pump should be at the upright position.

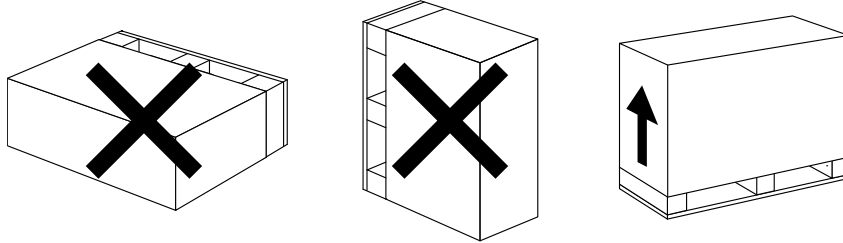

1.2. When moving the heat pump, do not lift the water union since the titanium heat exchanger inside the heat pump will be damaged.

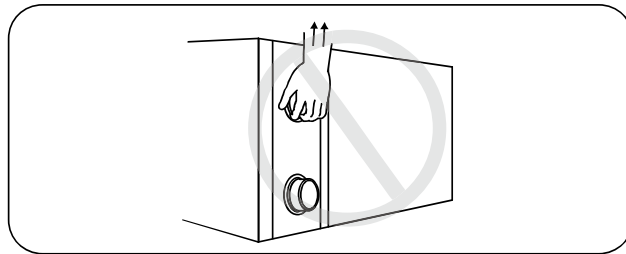

2. INSTALLATION AND MAINTENANCE

⚠ The heat pump must be installed by a professional team. The users are not qualified to install by themselves, otherwise the heat pump might be damaged and risky for users' safety.

2.1. Notice before installation:

2.1.1. The inlet and outlet water unions **can't** bear the weight of soft pipes. The heat pump must be connected with hard pipes!

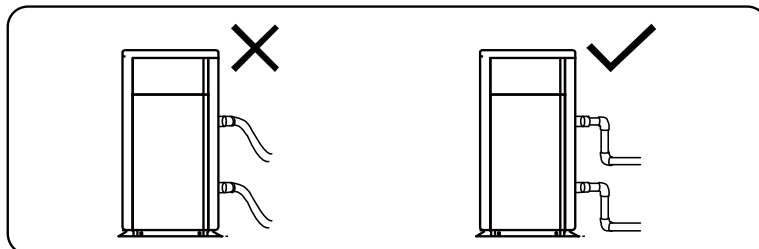

2.1.2. In order to guarantee the heating efficiency, the water pipe length should be $\leq 10\text{m}$ between the pool and the heat pump.

2.2. Installation instruction

2.2.1. Location and size

! To avoid air recirculation, the heat pump should be installed in a place with good ventilation or should reserve sufficient space for installation and maintenance. Please refer to the schema below:

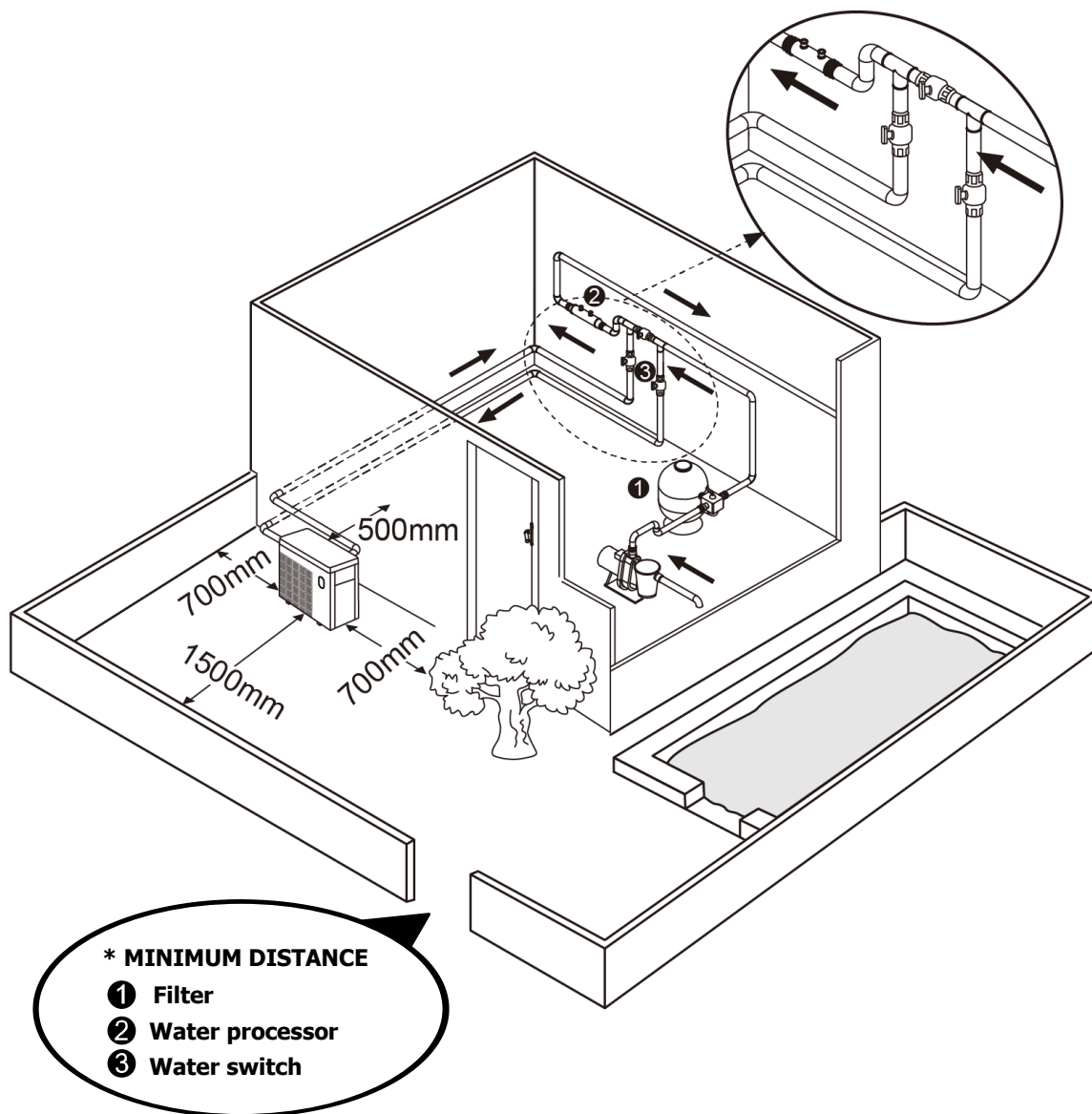

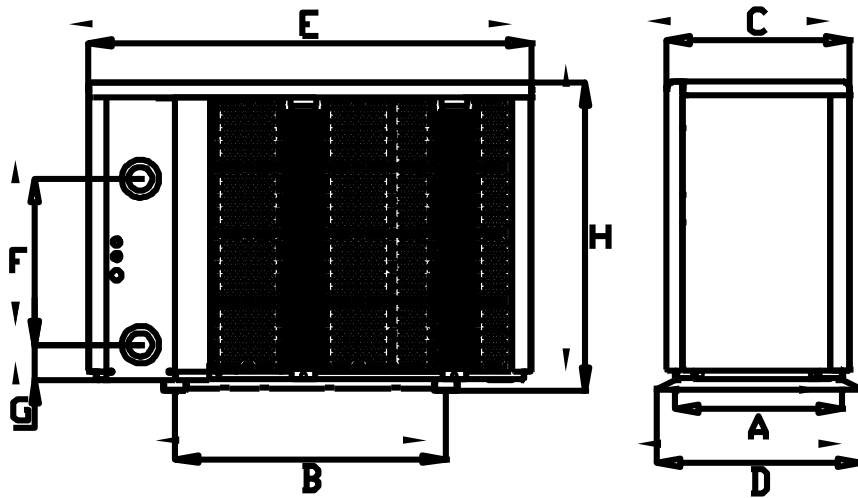

UNIT=MM		A	B	C	D	E	F	G	H
MODEL	IXCR26	407	434	390	432	799	300	74	650
	IXCR36	407	528	390	432	893	280	74	650
	IXCR46	407	574	390	432	939	350	74	650
	IXCR56	407	630	390	432	995	460	74	750
	IXCR66	404	760	384	429	1125	600	74	952
	IXCR80	514	710	493	539	1074	640	74	947
	IXCR80T	514	710	493	539	1074	640	74	947
	IXCR110T	514	900	493	539	1264	650	74	947

※ Above data is subject to modification without notice.

2.2.2.Heat pump installation.

- The frame must be fixed by bolts (**M10**) to concrete foundation or brackets. The concrete foundation must be solid; the bracket must be strong enough and anti-rust treated;
- The heat pump needs a water pump (**Supplied by the user**). The recommended pump specification-flux: refer to Technical Parameter, Max. lift **≥10m**
- When the heat pump is running, there will be condensation water discharged from the bottom, please pay attention to it. Please insert the drainage tube(accessory) into the hole and clip it well, then connect a pipe to drain off the condensation water.

2.2.3.Wiring & protecting devices and cable specification

- Connect to appropriate power supply, the voltage should comply with the rated voltage of the products.
- Well earth the heat pump.
- Wiring must be connected by a professional technician according to the circuit diagram.
- Set breaker or fuse according to the local code (leakage operating current **≤ 30mA**).

FOR INSTALLERS AND PROFESSIONALS

➤ The layout of power cable and signal cable should be orderly and not affecting each other.

⚠ 1. Connecting your power wire

1 2
3

- ✧ Please use cross screwdriver to take off the 2 screws at the bottom of the right side panel. Take off the lower half of the panel.
- ✧ Unscrew the 4 screws on the cover of the electrical box.
- ✧ Connect the terminals according to the electrical diagram.

⚠ 2. Wiring diagram

A. For power supply: 230V 50Hz

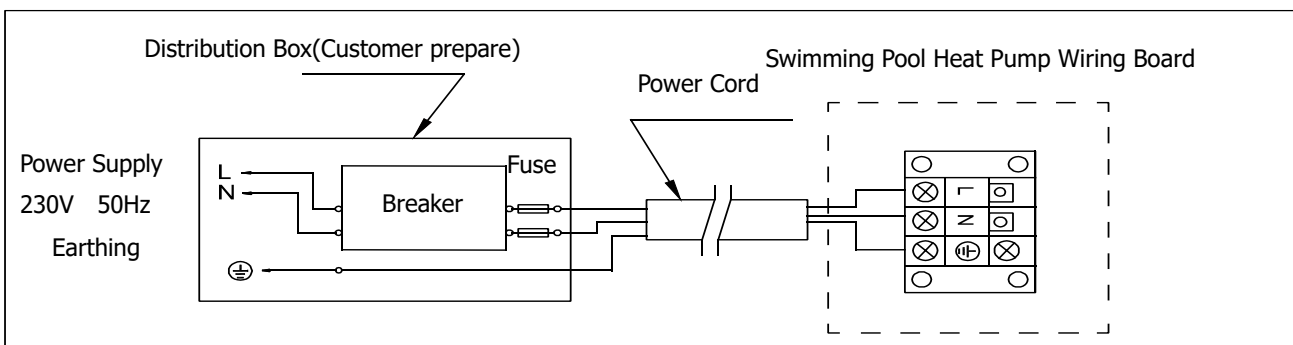

B. For power supply: 400V 50Hz

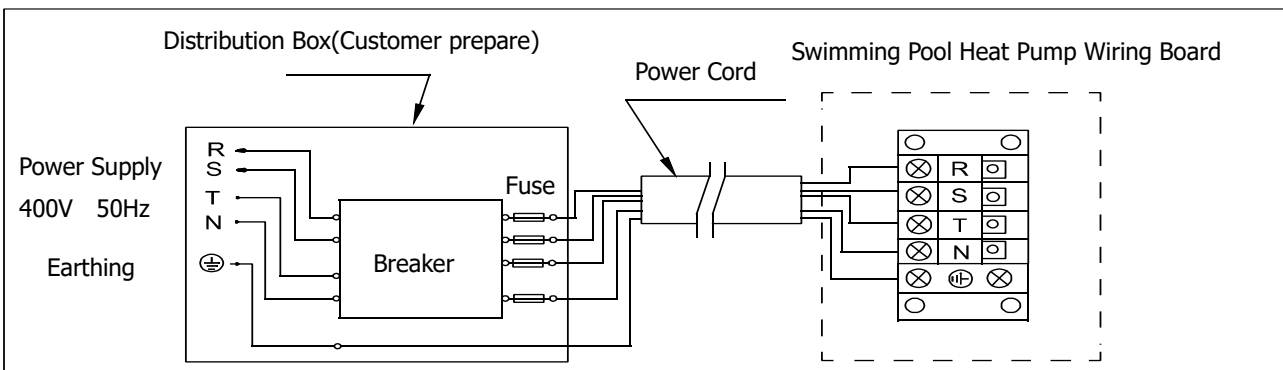

NOTE:

⚠ Must be hard wired, no plug allowed.

FOR INSTALLERS AND PROFESSIONALS

- For your safe use in winter, it's strongly recommended to equip heating priority function.
- For the detailed wiring diagram, please refer to Appendix 1.

3. Options for protecting devices and cable specification

MODEL		IXCR26	IXCR36	IXCR46	IXCR56	IXCR66	IXCR80	IXCR80T	IXCR110T
Breaker	Rated Current A	12.0	15.0	19.0	22.5	24.5	28.5	11.3	15.0
	Rated Residual Action Current mA	30	30	30	30	30	30	30	30
Fuse A		12.0	15.0	19.0	22.5	24.5	28.5	11.3	15.0
Power Cord (mm ²)		3×2.5	3×2.5	3×4	3×4	3×6	3×6	5×2.5	5×2.5
Signal cable (mm ²)		3×0.5	3×0.5	3×0.5	3×0.5	3×0.5	3×0.5	3×0.5	3×0.5

NOTE: The above data is adapted to power cord $\leq 10m$. If power cord is $>10m$, wire diameter must be increased. The signal cable can be extended to 50m at most.

2.3. Trial after installation

 **Please check all the wirings carefully before turning on the heat pump.**

2.3.1. Inspection before use

- Check installation of the whole heat pump and the pipe connections according to the pipe connecting drawing;
- Check the electric wiring according to the electrical wiring diagram and earthing connection;
- Make sure that the main power is well connected;
- Check if there is any obstacle in front of the air inlet and outlet of the heat pump

2.3.2. Trial

- The user is advised to start the water pump before the heat pump, and turn off the heat pump before the water pump for long life circle.
- The user should start the water pump, and check for any leakage of water; Power on and press the ON/OFF button of the heat pump, and set desired temperature in the thermostat.
- In order to protect the heat pump, the heat pump is equipped with start delay function. When starting the heat pump, the fan will start to run in 3 minutes, in another 30 seconds, the compressor will start to run.
- After pool heat pump starts up, check for any abnormal noise from the heat pump.
- Check the temperature setting.

2.4. Maintenance and winterizing

2.4.1 Maintenance

⚠️ The maintenance should be carried out once per year by qualified professional technician.

- Cut off power supply of the heat pump before cleaning, examination and repairing . Do not touch the electronic components until the LED indication lights on PCB turn off.
- Please clean the evaporator with household detergents or clean water, NEVER use gasoline, thinners or any similar fuel.
- Check bolts, cables and connections regularly.

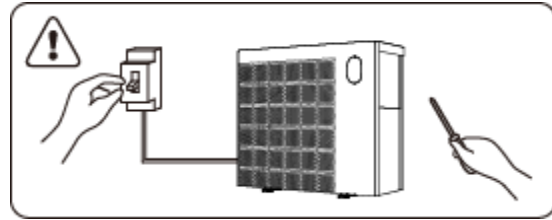

2.4.2 Winterizing

In winter season when you don't swim, please cut off power supply and drain water out of the heat pump. When using the heat pump under 2°C, make sure there is always water flow.

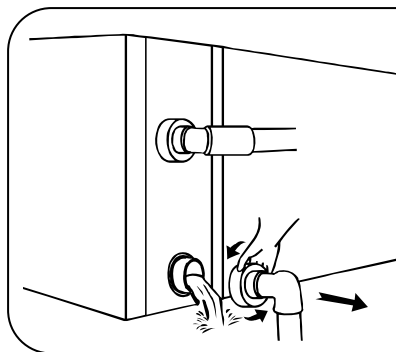

⚠️ Important:

Unscrew the water union of inlet pipe to let the water flow out. When the water in machine freezes in winter season, the titanium heat exchanger may be damaged.

3. TROUBLE SHOOTING FOR COMMON FAULTS

FAILURE	REASON	SOLUTION
Heat pump doesn't run	No power	Wait until the power recovers
	Power switch is off	Switch on the power
	Fuse burned	Check and change the fuse
	The breaker is off	Check and turn on the breaker
Fan running but with insufficient heating	evaporator blocked	Remove the obstacles
	Air outlet blocked	Remove the obstacles
	3 minutes start delay	Wait patiently
Display normal, but no heating	Set temp. too low	Set proper heating temp.
	3 minutes start delay	Wait patiently

If above solutions don't work, please contact your installer with detailed information and your model number. Don't try to repair it yourself.

ATTENTION! Please don't try to repair the heat pump by yourself to avoid any risk.

4. FAILURE CODE

NO.	DISPLAY	NOT FAILURE DESCRIPTION
1	E3	No water protection
2	E5	Power supply excesses operation range
3	E6	Excessive temp difference between inlet and outlet water(Insufficient water flow protection)
4	Eb	Ambient temperature too high or too low protection
5	Ed	Anti-freezing reminder
NO.	DISPLAY	FAILURE DESCRIPTION
1	E1	High pressure protection
2	E2	Low pressure protection
3	E4	3 phase sequence protection (three phase only)
4	E7	Water outlet temp too high or too low protection
5	E8	High exhaust temp protection
6	EA	Evaporator overheat protection (only at cooling mode)
7	P0	Controller communication failure
8	P1	Water inlet temp sensor failure
9	P2	Water outlet temp sensor failure
10	P3	Gas exhaust temp sensor failure
11	P4	Evaporator coil pipe temp sensor failure
12	P5	Gas return temp sensor failure
13	P6	Cooling coil pipe temp sensor failure
14	P7	Ambient temp sensor failure
15	P8	Cooling plate sensor failure
16	P9	Current sensor failure
17	PA	Restart memory failure
18	F1	Compressor drive module failure
19	F2	PFC module failure
20	F3	Compressor start failure
21	F4	Compressor running failure
22	F5	Inverter board over current protection
23	F6	Inverter board overheat protection
24	F7	Current protection
25	F8	Cooling plate overheat protection
26	F9	Fan motor failure
27	Fb	Power filter plate No-power protection
28	FA	PFC module over current protection

APPENDIX 1: HEATING PRIORITY WIRING DIAGRAM (OPTIONAL)

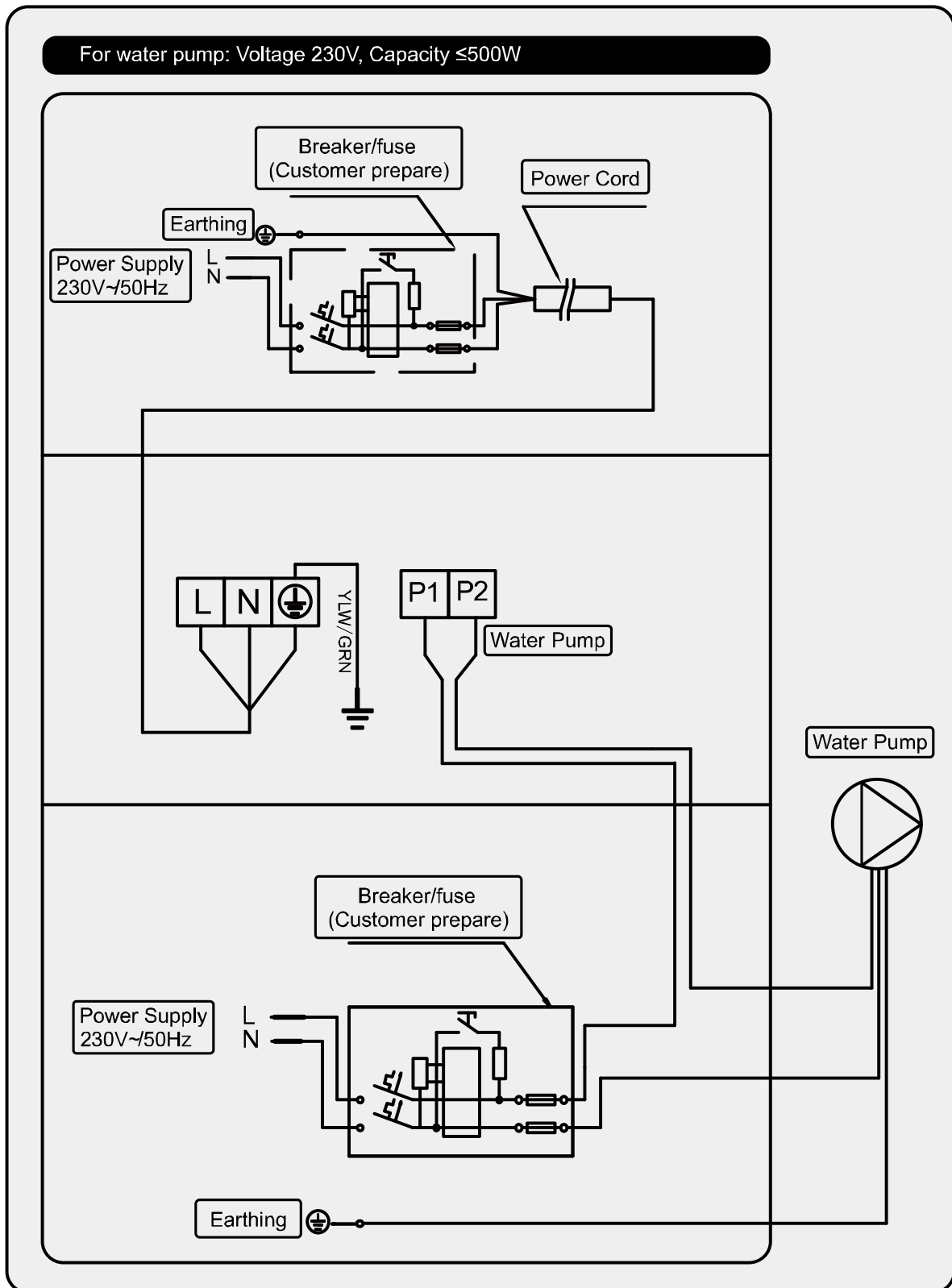

APPENDIX 2: HEATING PRIORITY WIRING DIAGRAM (OPTIONAL)

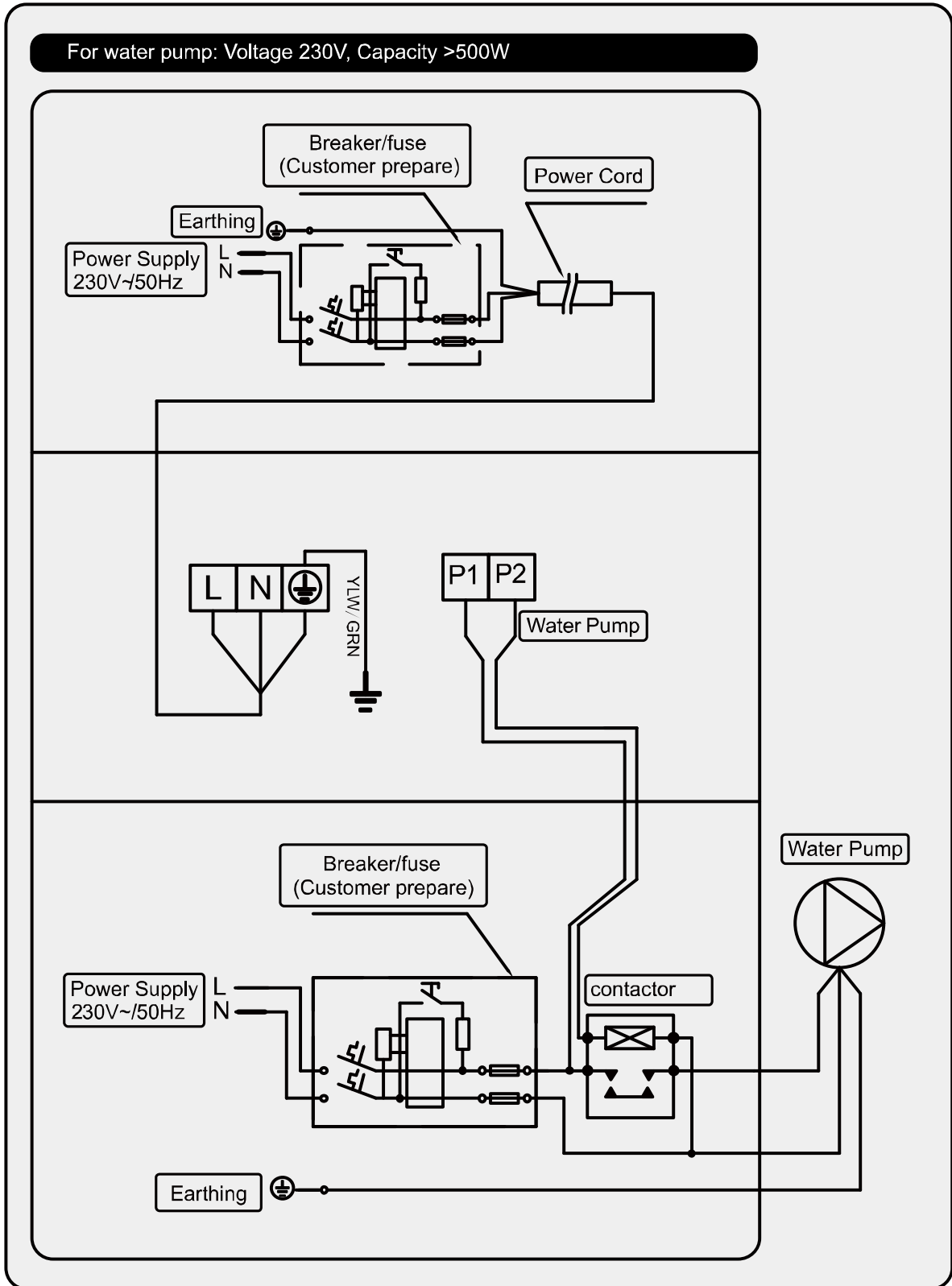

APPENDIX 3: HEATING PRIORITY WIRING DIAGRAM (OPTIONAL)

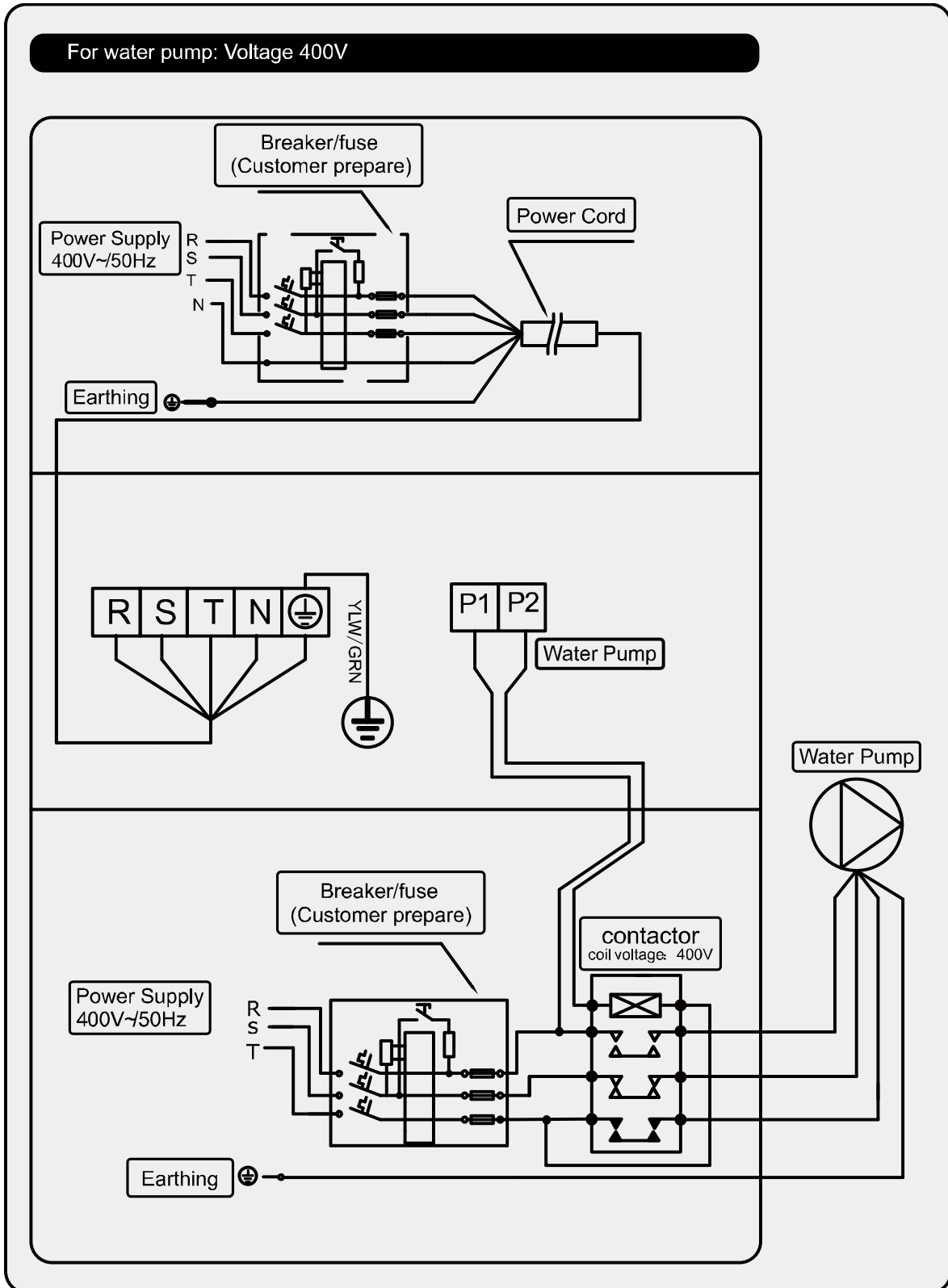

Parallel connection with filtration clock

A: Water pump timer

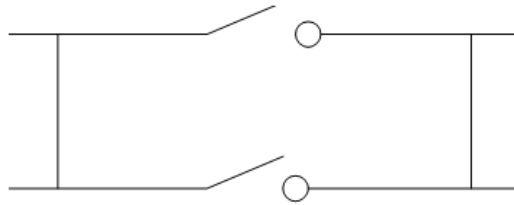

B: Water pump wiring of Heat Pump

Note: The installer should connect A parallel with B (as above picture). To start the water pump, condition A or B is connected. To stop the water pump, both A and B should be disconnected.

5. WIFI SETTING

1) APP Download



Android mobile please download from



iphone please download from



2) Account registration

a) Registration by Cell phone number/Email

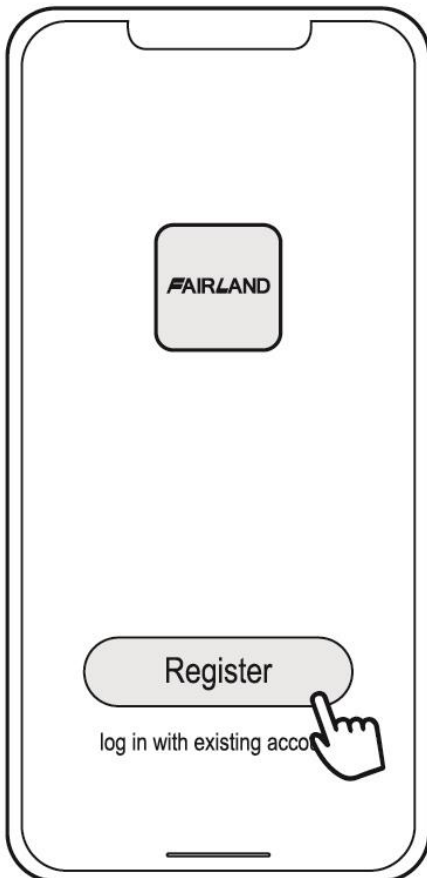

b) Cell phone number registration

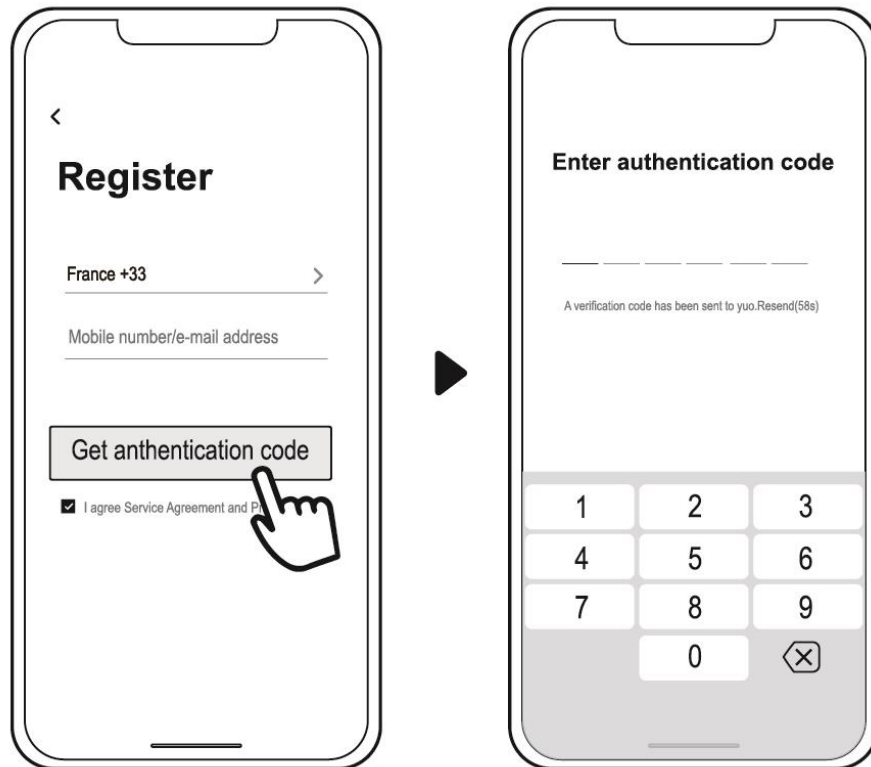

3) Create family

Please set family name and choose the room of device



4) APP Binding

Please make sure your cell phone has connected the Wifi

a) Wifi connection:

Press  for 3 seconds after screen unlock,  will be flashing to enter Wifi binding program.



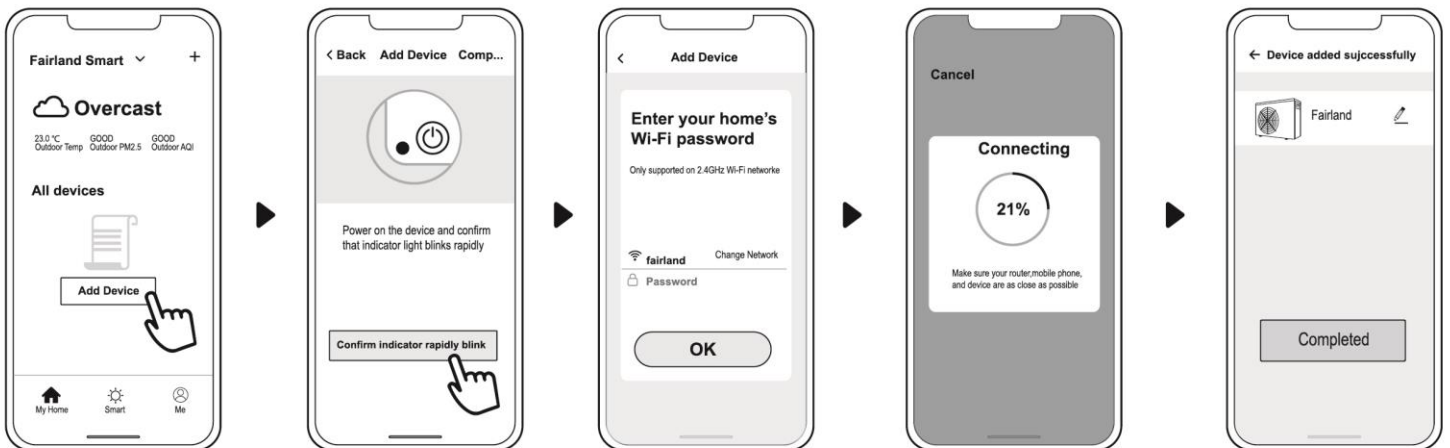

b) Click "Add device", follow indication to finish binding.  display on the screen once Wifi connection success.



c) If connect fails, please make sure your network name and password is correct. And your router, mobile phone and device are as close as possible.

d) Wifi rebinding (When Wifi password changes or network configuration changes):

Press  for 10 seconds,  will be flashing slowly for 60 seconds. Then  will be off. The original binding will be removed. Follow step above for rebinding.

Remarks: Please make sure the router is configured at 2.4G.

5) Operation

For heat pump with Heating & Cooling function.

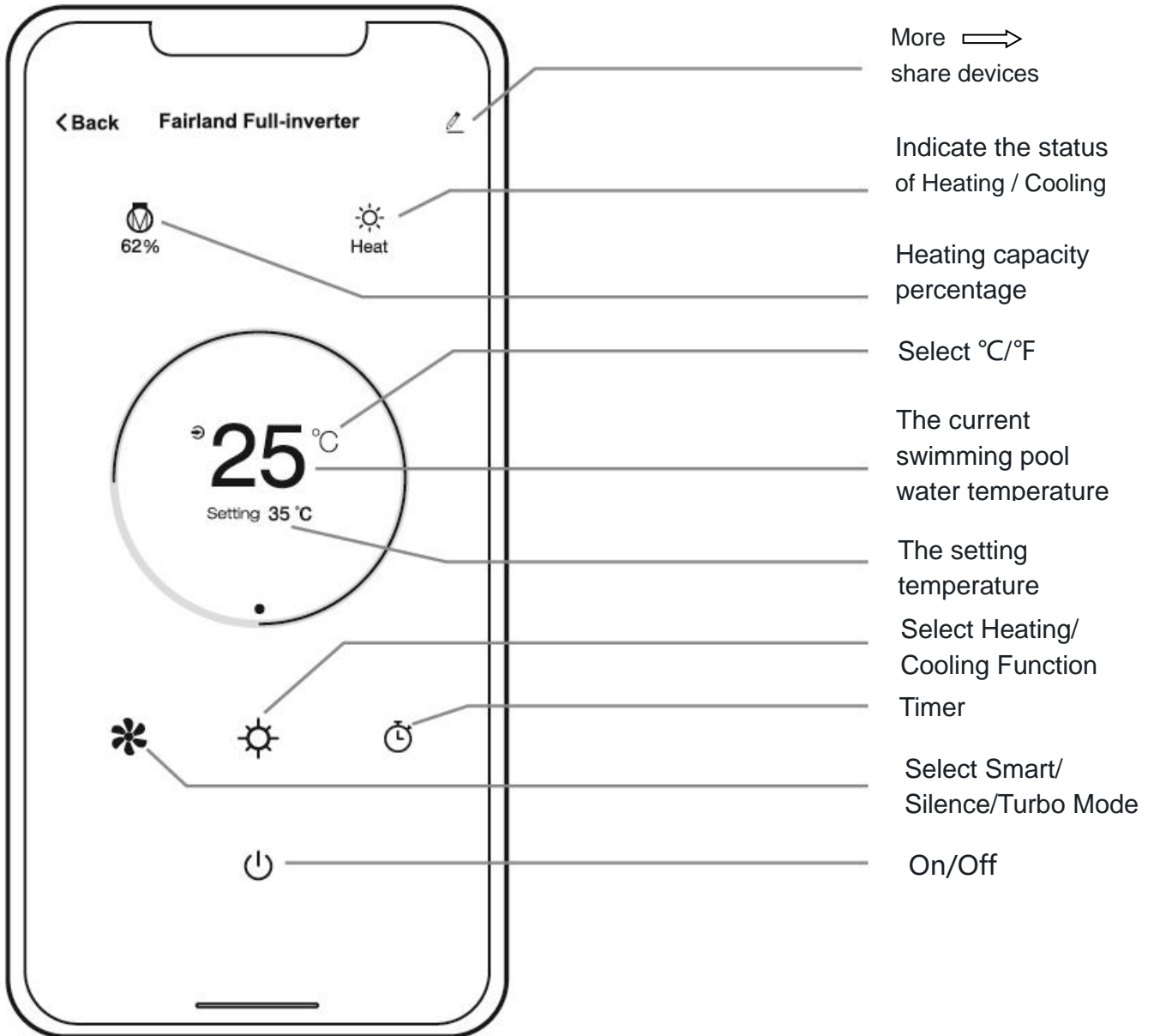

6) Share devices to your family members

After binding, if your family members also want to control the device.

Please let your family members register the APP first, and then the administrator can operate as below:

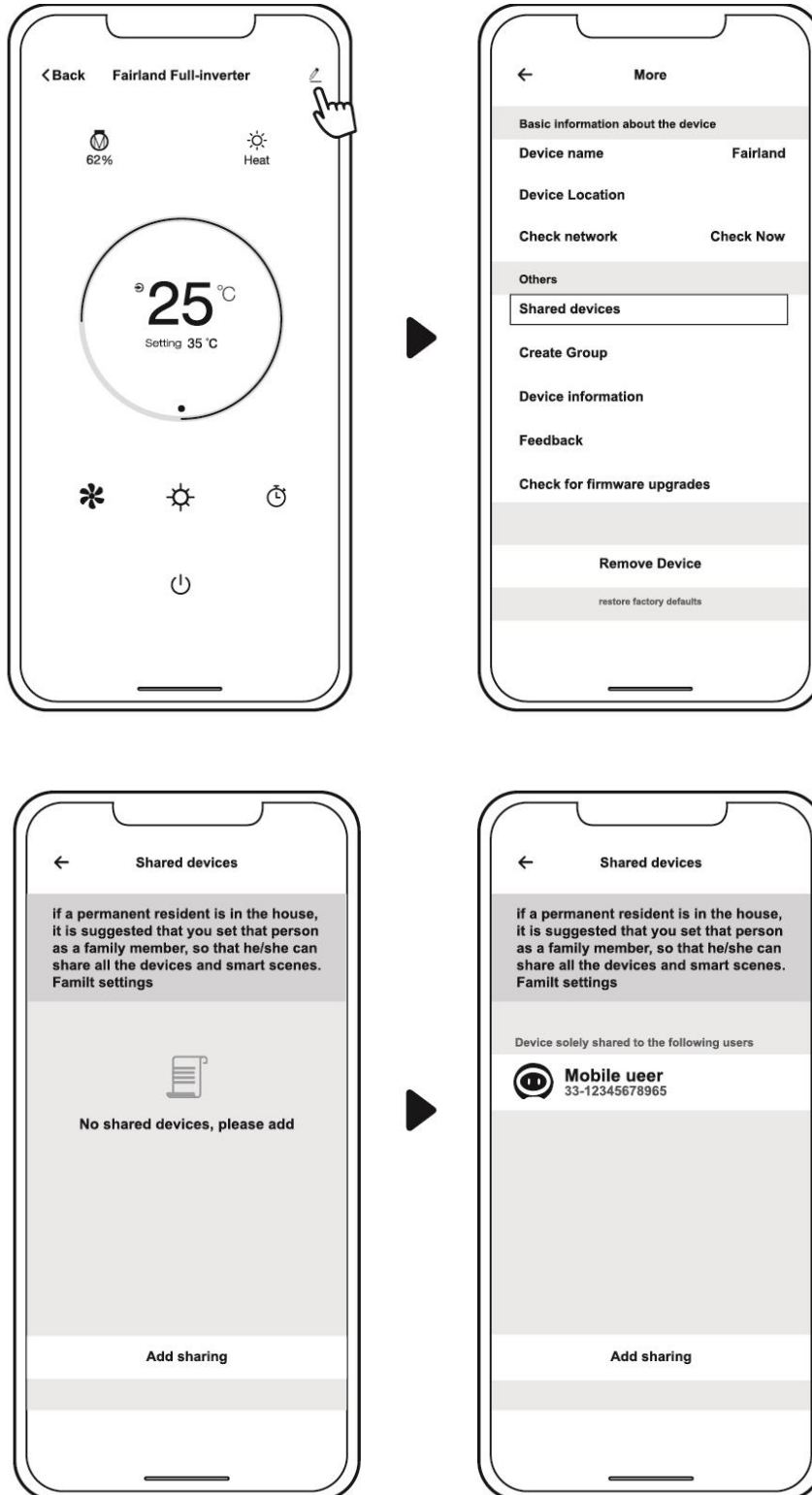

FOR INSTALLERS AND PROFESSIONALS

Then your family members can log in as below:

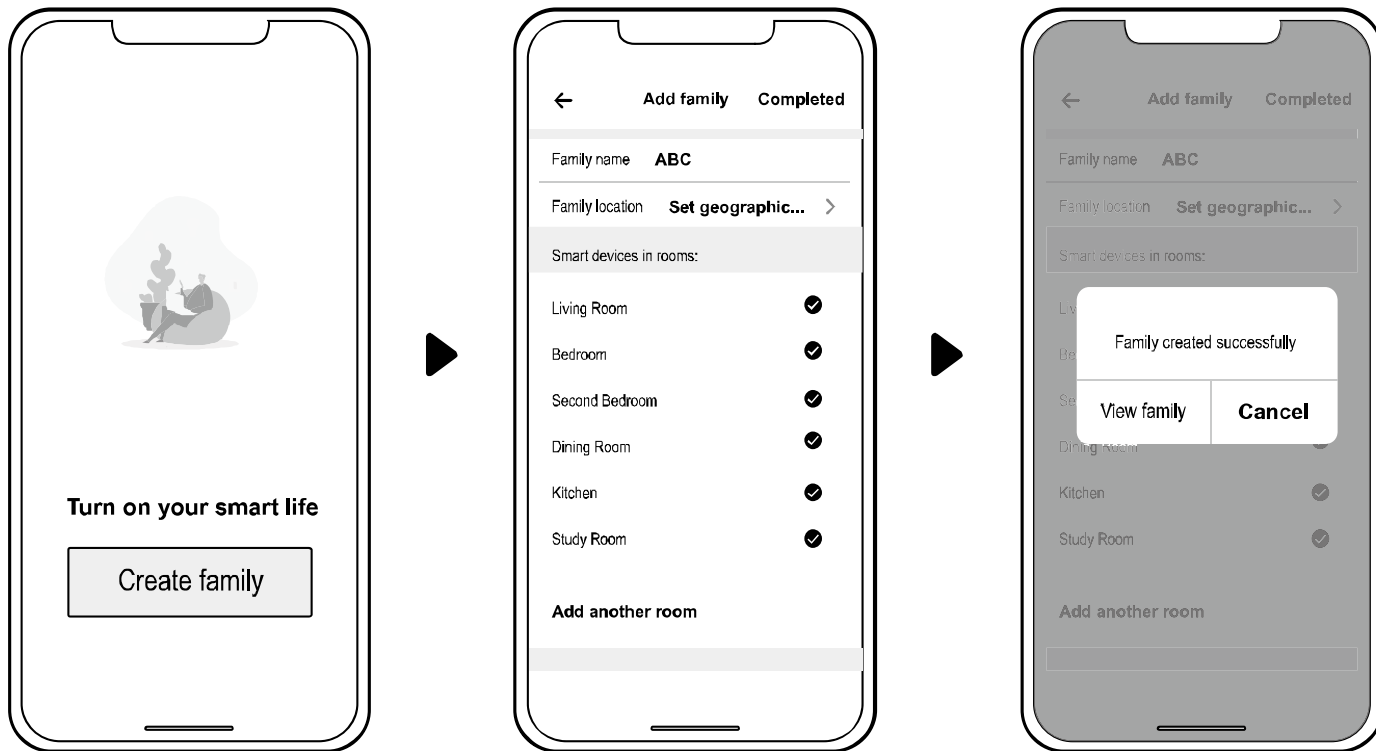

Notice: 1. The weather forecast is just for reference.

2. APP is subject to updating without notice.

Thank you for choosing Fairland TurboSilence Inverter.

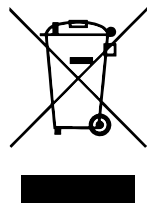

Version:D00Xr32



Service and support:

Aquashop Hungária Kft.

Location:

H-1116 Budapest, Kondorosi út 3.

faEmail:

info@aquashop.hu